

INCH-POUND  
MIL-HDBK-1165  
7 April 1997

DEPARTMENT OF DEFENSE  
HANDBOOK

WATER CONSERVATION



AMSC N/A

AREA FACR

DISTRIBUTION STATEMENT A. Approved for public release;  
distribution is unlimited.

ABSTRACT

Water conservation, maximizing the efficient use of water resources, is rapidly becoming a critical part of many military operations as more and more demands are placed upon existing water supplies. In order to remain a good neighbor and preserve the environment in which we live, engineers throughout the Department of Defense are frequently called upon to review the beneficial use of their water resources. This military handbook provides numerous methods to increase water efficiency and details the requirements of Executive Order 12902 as it relates to water conservation within the Department of Defense. In addition, this handbook also includes, in its appendices, procedures for submitting water conservation projects for central funding programs.

FOREWORD

This handbook is designed to provide guidance to the installation energy or facilities manager and project designers in the area of water conservation. This handbook is intended to assist installations in reducing their water consumption and thereby assist in complying with the provisions of Executive Order 12902.

Recommendations for improvement are encouraged from within the Navy, other government agencies, and the private sector and should be furnished on the DD Form 1426 provided inside the back cover to Commander, Naval Facilities Engineering Command, Code 161B, 1510 Gilbert Street, Norfolk, VA 23511-2699, phone (757) 322-4625.

DO NOT USE THIS HANDBOOK AS A REFERENCE IN A PROCUREMENT DOCUMENT FOR FACILITIES CONSTRUCTION. IT IS TO BE USED IN THE PURCHASE AND PREPARATION OF FACILITIES PLANNING AND ENGINEERING STUDIES AND DESIGN DOCUMENTS USED FOR THE PROCUREMENT OF FACILITIES CONSTRUCTION (SCOPE, BASIS OF DESIGN, TECHNICAL REQUIREMENTS, PLANS, SPECIFICATIONS, COST ESTIMATES, REQUEST FOR PROPOSALS, AND INVITATION FOR BIDS). DO NOT REFERENCE IT IN MILITARY OR FEDERAL SPECIFICATIONS OR OTHER PROCUREMENT DOCUMENTS.

MIL-HDBK-1165

(THIS PAGE LEFT INTENTIONALLY BLANK)

## WATER CONSERVATION

## CONTENTS

		<u>Page</u>
Section 1	INTRODUCTION	
1.1	Scope .....	1
1.2	Applicability .....	1
1.3	Cancellation .....	1
Section 2	WATER - AN OVERVIEW	
2.1	Water Conservation - The Law of the Land .....	3
2.1.1	Executive Order 12902 .....	3
2.1.2	Environmental Compliance .....	3
2.2	A New Outlook on Water .....	5
2.2.1	Water Availability .....	5
2.2.2	Water Facts .....	6
2.2.3	Water Conservation Benefits .....	6
2.3	Water Usage in the Federal Government .....	6
2.4	Typical Water Uses .....	9
2.5	Typical Water Abuses .....	9
2.6	Water Costs .....	10
2.6.1	Total and Marginal Costs of Water .....	11
Section 3	WATER CONSERVATION PLANNING	
3.1	Developing a Water Conservation Plan .....	13
3.1.1	Step 1 - Analyze Water Usage .....	13
3.1.1.1	The Prioritization Survey .....	13
3.1.1.2	The Facility Water Audit .....	13
3.1.2	Step 2 - Develop Water Use Forecasts .....	16
3.1.3	Step 3 - Explore Options .....	16
3.1.3.1	Long Term - vs - Short Term Reliability .....	16
3.1.3.2	Capability-Building .....	16
3.1.3.3	Avoid Lost Opportunities .....	16
3.1.3.4	Social Acceptability .....	17
3.1.4	Step 4 - Analyze the Benefits and Costs .....	17
3.1.4.1	Costs .....	17
3.1.4.2	Benefits .....	17
3.1.5	Step 5 - Develop Long-Term Plan .....	18
3.2	Drought Management Plan .....	18
3.3	Public Education and Involvement .....	18
3.3.1	Public Information .....	19
Section 4	WATER CONSERVATION OPTIONS: SUPPLY	
4.1	Introduction .....	20
4.2	Water Wells and Treatment Plants .....	20

		<u>Page</u>
4.3	Leak Detection Programs .....	20
4.4	Metering .....	20
4.5	Pressure Reduction .....	21
Section 5	WATER CONSERVATION OPTIONS: END USE	
5.1	Introduction .....	22
5.2	Office Facilities and Residential .....	22
5.2.1	Toilets .....	25
5.2.1.1	Conventional and Water-Efficient .....	25
5.2.1.2	Operation and Maintenance Procedures .....	26
5.2.1.3	Retrofits .....	26
5.2.1.4	Replacements .....	27
5.2.1.5	Problems and Pitfalls .....	27
5.2.2	Urinals .....	28
5.2.2.1	Conventional and Water-Efficient .....	28
5.2.2.2	Operation and Maintenance Procedures .....	29
5.2.2.3	Retrofits .....	29
5.2.2.4	Replacements .....	29
5.2.2.5	Problems and Pitfalls .....	29
5.2.3	Showerheads .....	30
5.2.3.1	Conventional and Water-Efficient .....	30
5.2.3.2	Operation and Maintenance Procedures .....	30
5.2.3.3	Retrofits .....	30
5.2.3.4	Replacements .....	31
5.2.3.5	Problems and Pitfalls .....	31
5.2.4	Faucets .....	32
5.2.4.1	Conventional and Water-Efficient .....	32
5.2.4.2	Operation and Maintenance Procedures .....	32
5.2.4.3	Retrofits .....	32
5.2.4.4	Replacements .....	32
5.2.4.5	Problems and Pitfalls .....	33
5.2.5	Chilled Drinking Fountains and Ice Machines ...	34
5.2.5.1	Replacements .....	34
5.2.6	Washing Machines .....	34
5.2.6.1	Conventional and Water-Efficient .....	34
5.2.6.2	Operation and Maintenance Procedures .....	34
5.2.6.3	Retrofits .....	34
5.2.6.4	Replacements .....	35
5.2.6.5	Problems and Pitfalls .....	35
5.2.7	Dishwashers .....	35
5.2.7.1	Conventional and Water-Efficient .....	35
5.2.7.2	Operation and Maintenance Procedures .....	35
5.2.7.3	Retrofits .....	36
5.2.7.4	Replacements .....	36
5.2.7.5	Problems and Pitfalls .....	37

	<u>Page</u>	
5.2.8	Garbage Disposals .....	37
5.2.9	Water Softeners .....	38
5.2.9.1	Operation and Maintenance Procedures .....	38
5.2.9.2	Replacements .....	38
5.2.9.3	Problems and Pitfalls .....	38
5.3	Industrial Operations .....	38
5.3.1	Washrack Cleaning Facilities .....	38
5.3.1.1	Conventional and Water-Efficient .....	38
5.3.1.2	Operation and Maintenance Procedures .....	39
5.3.1.3	Retrofits .....	39
5.3.1.4	Water Recycling, Reclamation, and Reuse .....	40
5.3.2	Plating Facilities .....	42
5.3.2.1	Conventional and Water-Efficient .....	43
5.3.2.2	Operation and Maintenance Procedures .....	43
5.3.2.3	Retrofits .....	43
5.3.2.4	Water Recycling, Reclamation, and Reuse .....	46
5.3.3	Metal Cleaning Facilities .....	48
5.3.3.1	Water Recycling, Reclamation, and Reuse .....	49
5.3.4	Painting/Paint Stripping Facilities .....	49
5.3.4.1	Conventional and Water-Efficient .....	49
5.3.4.2	Operational and Maintenance Procedures .....	49
5.3.4.3	Replacements .....	50
5.3.4.4	Water Recycling, Reclamation, and Reuse .....	51
5.3.5	Industrial Laundries .....	51
5.3.5.1	Conventional and Water-Efficient .....	51
5.3.5.2	Operation and Maintenance Procedures .....	53
5.3.5.3	Retrofits .....	53
5.3.5.4	Replacements .....	53
5.3.5.5	Water Recycling, Reclamation, and Reuse .....	54
5.3.5.6	Problems and Pitfalls .....	55
5.4	HVAC Equipment .....	56
5.4.1	Cooling Towers, Evaporative Coolers, and Once-Through Cooling Systems .....	56
5.4.1.1	Conventional .....	56
5.4.1.2	Operation and Maintenance Procedures .....	58
5.4.1.3	Retrofits .....	58
5.4.1.4	Replacements .....	59
5.4.1.5	Chemical Additives .....	59
5.4.1.6	Ozone Injection .....	60
5.4.1.7	Water Recycling, Reclamation, and Reuse .....	60
5.4.1.8	Magnets/Electrostatic Field Generators .....	61
5.4.2	Water Heaters .....	61
5.4.2.1	Conventional and Water-Efficient .....	61
5.4.2.2	Operation and Maintenance Procedures .....	62
5.4.2.3	Retrofits .....	62

	<u>Page</u>	
5.4.2.4	Replacements .....	63
5.4.3	Boilers and Steam Generators .....	64
5.4.3.1	Operation and Maintenance Procedures .....	65
5.4.3.2	Retrofits .....	65
5.4.3.3	Replacements .....	65
5.4.3.4	Chemical Use .....	65
5.4.3.5	Water Recycling, Reclamation, and Reuse .....	65
5.5	Medical Facilities .....	66
5.5.1	X-ray Equipment .....	66
5.5.1.1	Operation and Maintenance Procedures .....	66
5.5.1.2	Retrofits .....	66
5.5.1.3	Water Recycling, Reclamation, and Reuse .....	66
5.5.2	Sterilizers and Autoclaves .....	66
5.5.2.1	Operation and Maintenance Procedures .....	67
5.5.2.2	Retrofits .....	67
5.5.2.3	Replacements .....	67
5.6	Irrigation and Landscaping .....	67
5.6.1	Operation and Maintenance Procedures .....	67
5.6.2	Retrofits .....	68
5.6.3	Replacements .....	68
5.6.4	Xeriscape .....	69
5.6.4.1	Planning and Design .....	69
5.6.4.2	Limited Turf Area .....	70
5.6.4.3	Efficient Irrigation .....	70
5.6.4.4	Soil Improvements .....	70
5.6.4.5	Use of Mulches .....	70
5.6.4.6	Use of Low-Water-Demand Plants .....	73
5.6.4.7	Appropriate Maintenance .....	73
5.6.4.8	Water Recycling, Reclamation, and Reuse .....	73
5.6.5	Graywater .....	73
5.6.6	Subsurface Irrigation .....	74
5.6.7	Rainwater Catchment .....	75
5.7	Swimming Pools and Spas .....	75
5.7.1	Conventional and Water-Efficient .....	75
Section 6	WATER CONSERVATION OPTIONS: DISPOSAL	
6.1	Sewage Treatment .....	76
6.2	Water Recycling, Reclamation, and Reuse .....	76
6.2.1	Types of Wastewater .....	76
6.2.2	Retrofits .....	77
Section 7	WATER CONSERVATION SUPPORT	
7.1	Software Programs .....	79
7.1.1	FEDS .....	79
7.1.1.1	Vendor Information .....	79



MIL-HDBK-1165

	<u>Page</u>
7.1.2	IWRAPS ..... 79
7.1.2.1	Vendor Information ..... 80
7.1.3	WATERGY ..... 80
7.1.3.1	Vendor Information ..... 80
7.1.4	WAVE-Saver ..... 80
7.1.4.1	Vendor Information ..... 81
7.1.5	Water Management Tool for Federal Office Buildings ..... 81
7.1.5.1	Vendor Information ..... 81
7.1.6	Leak Audit ..... 81
7.1.6.1	Vendor Information ..... 82
7.1.7	Residential Water Conservation Techniques ..... 82
7.1.7.1	Vendor Information ..... 82
7.1.8	WELP ..... 82
7.1.8.1	Vendor Information ..... 82
7.1.9	AWWA Software ..... 83
7.1.9.1	WATERNET ..... 83
7.1.9.2	Well System Manager Software ..... 83
7.1.9.3	WALTER ..... 83
7.1.9.4	Meter Inventory Software ..... 83
7.1.9.5	Vendor Information ..... 83
7.2	Internet Sites ..... 83
7.3	Additional Reading ..... 84
7.3.1	American Water Works Association ..... 84
7.3.2	Rocky Mountain Institute ..... 85
7.3.3	Environmental Services Department ..... 86
7.3.4	Other Publications ..... 86

APPENDICES

APPENDIX A	Executive Order 12902 Summary ..... 88
APPENDIX B	Water Audit Survey Forms ..... 90
APPENDIX C	Army Specific Program, Resources and POC's ..... 101
APPENDIX D	Navy Specific Program, Resources and POC's ..... 103
APPENDIX E	Air Force Specific Program, Resources and POC's ..... 113
APPENDIX F	Marine Corps Specific Program, Resources and POC's ..... 117

FIGURES

Figure 1	Flowchart of the Requirements of EO 12902 for Water Conservation ..... 2
----------	-----------------------------------------------------------------------------

MIL-HDBK-1165

	<u>Page</u>
Figure 2	Roles of Key Agencies in Water Conservation ..... 4
Figure 3	Typical Water Usage at Military Installations ..... 7
Figure 4	Typical Water Usage in Family Housing ..... 8
Figure 5	Typical Water Usage in Office/ Administration Buildings ..... 9
Figure 6	Average Cost of Water (FY93) for Selected Sites ..... 10
Figure 7	Marginal Costs and Total Costs of Water ..... 12
Figure 8	General Parts of a Water Audit ..... 14
Figure 9	Potential Water Savings for Various Plumbing Fixtures ..... 23
Figure 10	Water Usage Rates of Bathroom Plumbing Fixtures ..... 24
Figure 11	Water Lost Through Leaks ..... 26
Figure 12	Washrack Water Requirements ..... 39
Figure 13	Two Types of Washrack Water Reclamation Systems ..... 41
Figure 14	Drain Board and Drip Bar ..... 45
Figure 15	Two Types of Spray Booths ..... 52
Figure 16	Industrial Laundry Water Quality ..... 55
Figure 17	Typical Cooling Tower Operation ..... 57
Figure 18	Typical Natural Gas Water Heater ..... 64
Figure 19	Drought Tolerant Plants ..... 71
Figure 20	Sample Yard Xeriscape ..... 74
Figure 21	Typical Graywater Piping and Distribution System ..... 78
Figure 22	Water Related Sites on the Internet ..... 84
REFERENCES	..... 120
GLOSSARY	..... 123

Section 1: INTRODUCTION

1.1 Scope. This handbook provides comprehensive guidance to the facility engineer in the area of water conservation. Numerous ideas of potential water conserving technologies are presented along with avenues of funding for such projects. Executive Order 12902, as it relates to water conservation, is discussed and guidance is provided for establishing water conservation programs at military installations. Additionally, the appendices include detailed provisions for developing and submitting water conservation projects to higher headquarters for appropriate funding. This handbook is for guidance only. This handbook cannot be cited as a requirement. If it is, the contractor does not have to comply.

1.2 Applicability. This handbook is applicable to all military shore installations. While not every water conservation measure presented in this handbook may be applicable at every military installation, the overall guidance and programs presented will be applicable. Overseas handbook may be applicable at every military installation, the installations are cautioned to review their host nation agreements to determine if the conservation measures discussed in this handbook can be implemented.

1.3 Cancellation. This handbook is new. No existing manuals or handbooks have been superseded or canceled by this publication.

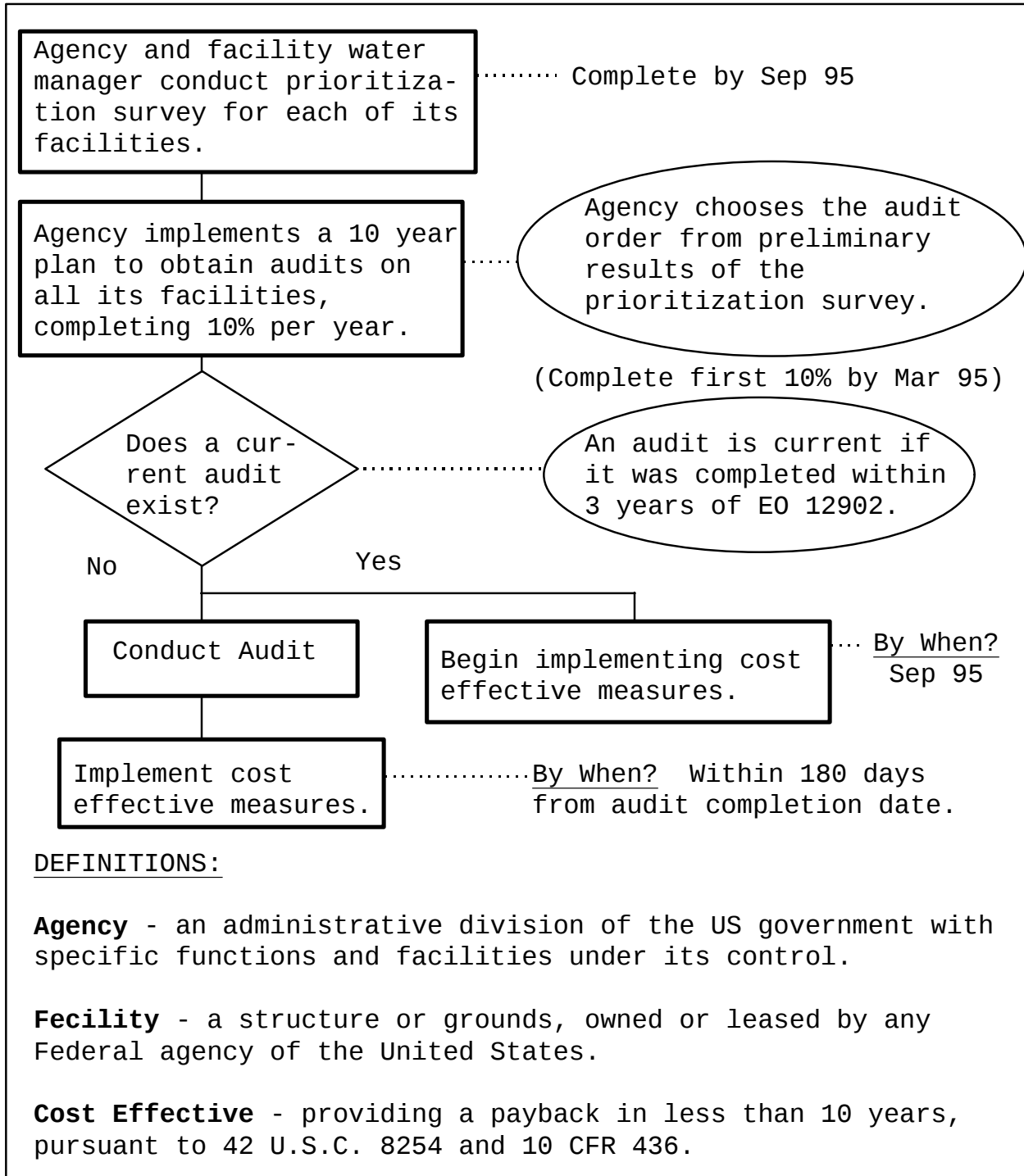

Figure 1  
Flowchart of the Requirements of EO 12902 for Water Conservation

Section 2: WATER - AN OVERVIEW

2.1 Water Conservation - The Law of the Land

2.1.1 Executive Order 12902. In March of 1994, Executive Order (EO) 12902 was issued as a follow-up to the Energy Policy Act of 1992. EO 12902 states that all federal agencies are to take specific actions to conserve energy and water at their facilities. The Executive Order mandates that agencies within the federal government reduce energy consumption in federal buildings by 30 percent from 1985 levels by the year 2005. Although the requirements described for energy conservation are more detailed, EO 12902 provides inclusive requirements for water conservation. Figure 1 shows a flowchart presenting the requirements in a step-wise fashion. Appendix A contains a summary of EO 12902 as it applies to water conservation.

Fortunately, EO 12902 also states how agencies and you, the facility water manager, are to be assisted by the Department of Energy (DOE) and the General Services Administration (GSA) in completing the above daunting tasks! The role of DOE is to take the lead in implementing EO 12902 through the Federal Energy Management Program (FEMP). The FEMP office was established within DOE over a decade ago to facilitate improvement of energy and water conservation practices among federal agencies, and to coordinate and support the development and application of tools, techniques, and strategies to improve energy and water efficiency in the federal sector. According to the Executive Order, DOE, GSA, and each Federal facility has its own unique role in implementing water conservation. Figure 2 shows the duties of DOE, GSA, each Service's Lead Agency, and each Federal facility in federal energy and water management.

In addition to conserving water used in existing facilities, water conservation techniques should also be applied to the design of new facilities. Project designers should consider the water conservation options discussed in Sections 4 through 6 and implement those which are cost effective.

2.1.2 Environmental Compliance. Saving dollars and energy is not the only reason that water conservation is important. Water is a critical, life sustaining resource and its use, or abuse, affects the surrounding environment. As water supplies decrease, the need to conserve water to protect the environment increases.

<b><u>Department of Energy</u></b>	
<ul style="list-style-type: none"> <li>S Implement E012902 through FEMP.</li> <li>S Develop indicators of water efficiency, usage and cost.</li> <li>S Prepare report on issues of instituting life cycle analysis.</li> <li>S Assist agencies in eliminating procurement barriers to implementing EO 12902.</li> <li>S Assist services to identify and implement water conservation opportunities.</li> <li>S Encourage water conservation in federal facilities (with GSA).</li> <li>S Develop program to train and support agency conservation project teams.</li> <li>S Through FEMP, develop an agency service program and assign</li> </ul>	<ul style="list-style-type: none"> <li>account managers to each agency.</li> <li>S Identify advanced technologies.</li> <li>S Provide guidance on retiring older water using equipment (with GSA).</li> <li>S Provide guidance on:                             <ul style="list-style-type: none"> <li>S Water and energy consumption and saving relationships.</li> <li>S Latest water conservation funding methods.</li> <li>S List of national water service companies.</li> <li>S Information on capabilities and technology through</li> <li>S National Energy labs.</li> <li>S List of federal water efficiency contractors.</li> </ul> </li> </ul>
<b><u>General Services Administration</u></b>	
<ul style="list-style-type: none"> <li>S Identify GSA contracted utilities which perform no-cost audits.</li> <li>S Determine utilities which offer demand-side services and incentives.</li> </ul>	<ul style="list-style-type: none"> <li>S Develop efficient procurement techniques, methods, and contracts.</li> <li>S Provide information on specific water conservation products.</li> </ul>
<b><u>Service Lead Agency</u></b>	
<ul style="list-style-type: none"> <li>S Assist DOD in implementing EO 12902.</li> <li>S Manage ECIP and FEMP funding for water and energy conservation projects.</li> <li>S Recommend projects to Secretary of Defense for</li> </ul>	<ul style="list-style-type: none"> <li>FY funding.</li> <li>S Issue service policies and guidelines to implement water conservation projects.</li> <li>S Develop service-side execution plan for water projects.</li> </ul>
<b><u>Facility</u></b>	
<p>Obtain assistance as needed from DOE, GSA, Service Support Agencies, etc., to:</p>	
<ul style="list-style-type: none"> <li>S Develop a facility water conservation plan.</li> <li>S Conduct facility water audit.</li> </ul>	<ul style="list-style-type: none"> <li>S Determine water conserving measures.</li> <li>S Implement water conservation measures.</li> </ul>

Figure 2  
Roles of Key Agencies in Water Conservation

As a result, more and more states are implementing restrictions on total water usage through the use of consumptive use permits. These permits allow water users to withdraw a limited quantity from the permitted sources. If your installation is located in an area that is prone to droughts, encompasses the habitat of an endangered species, or has other environmental requirements that may require less water use; these consumptive use permit levels may be set below your current usage. When funding for a water conservation project cannot be justified by FEMP payback criteria, but is still required for environmental reasons, project approval under compliance criteria must be obtained.

Other circumstances may arise where FEMP economic concerns are not the primary consideration for conservation. Discharge permit limitations, the economic advantages of avoiding the expansion of water or wastewater facilities, or a wide variety of other reasons could drive the decision to conserve water. If you find yourself in this situation, the methods discussed in this handbook for reducing your overall water usage are still valid and an excellent approach, but the funding process is different. Although FEMP criteria and funding should always be investigated and used when appropriate, both compliance and normal operations funding remain options when proper circumstances exist.

Since production, treatment, and transportation of water require energy and chemical usage, your efforts to conserve water also help to support the installation's pollution prevention goals. Reducing the use of chlorine and other chemicals, minimizing the amount and toxicity of sludge disposed from water and wastewater treatment, and reducing energy use allow the installation to avoid pollution and actually help to reduce the operational and financial impact of environmental compliance regulations. These regulations can be difficult to understand, so if you are faced with environmental compliance issues, contact your installation's environmental department for assistance.

## 2.2 A New Outlook on Water

2.2.1 Water Availability. Water and its future availability have usually been taken for granted in the United States. After all, water has always been a cheap commodity in the U.S., and the incentives for conserving this seemingly abundant resource have been minimal. However, with the population explosion in the second half of the twentieth century, we are now taking a new

view of our water resources. Existing rivers, lakes, and aquifers are all we have for water sources; therefore, we must protect them. A simple way to do this is to increase water efficiency, and thus decrease the demand on these sources.

2.2.2 Water Facts. Almost three-fourths of the earth's surface is water, yet 97 percent of the earth's water supply is ocean (salt) water. The remaining 3 percent is fresh, but two-thirds of this is in the form of ice caps and glaciers! The U.S. alone withdraws over 450 billion gallons of ground and surface water a day, at least three times the amount of water as the rest of the world, according to the US Geological Survey. After a rainfall, only 9 percent of the total precipitation is captured for beneficial use, the remaining 91 percent is lost to evaporation, transpiration, and runoff to stream flow (which is never withdrawn and ends up in the oceans).

2.2.3 Water Conservation Benefits. Beyond regulations and laws, the conservation of water is imperative to the future economic, social, and physical health of our country and world. Water is used in every facet of life, from agriculture and industry to residential and recreational. Besides the benefit of securing the world's water supply for the future, other important benefits can be derived from water conservation. Proper water management can lead to substantial financial savings. Remember, when water is conserved, energy savings are often observed due to lessened energy demands for treating, heating, cooling, and transporting the water. Pollution prevention benefits are realized in two ways: reduced energy means reduced air pollution, and less water treatment means less chemical usage.

2.3 Water Usage in the Federal Government. The federal government has not been exempt from the past practices of water overuse, abuse, and apathy. But, since most federal agencies do not know how much water they use, what the water is being used for, or the cost of that water, it is impossible to accurately state how much water the federal government actually uses. From data gathered by the Army Corps of Engineers in fiscal year 1989, however, it is known that global Army water and sewage costs were nearly \$250 million! This would put the total for the Department of Defense alone at approximately \$1 billion. At an average cost of \$2/1,000 gallon, this would equate to half a trillion gallons.



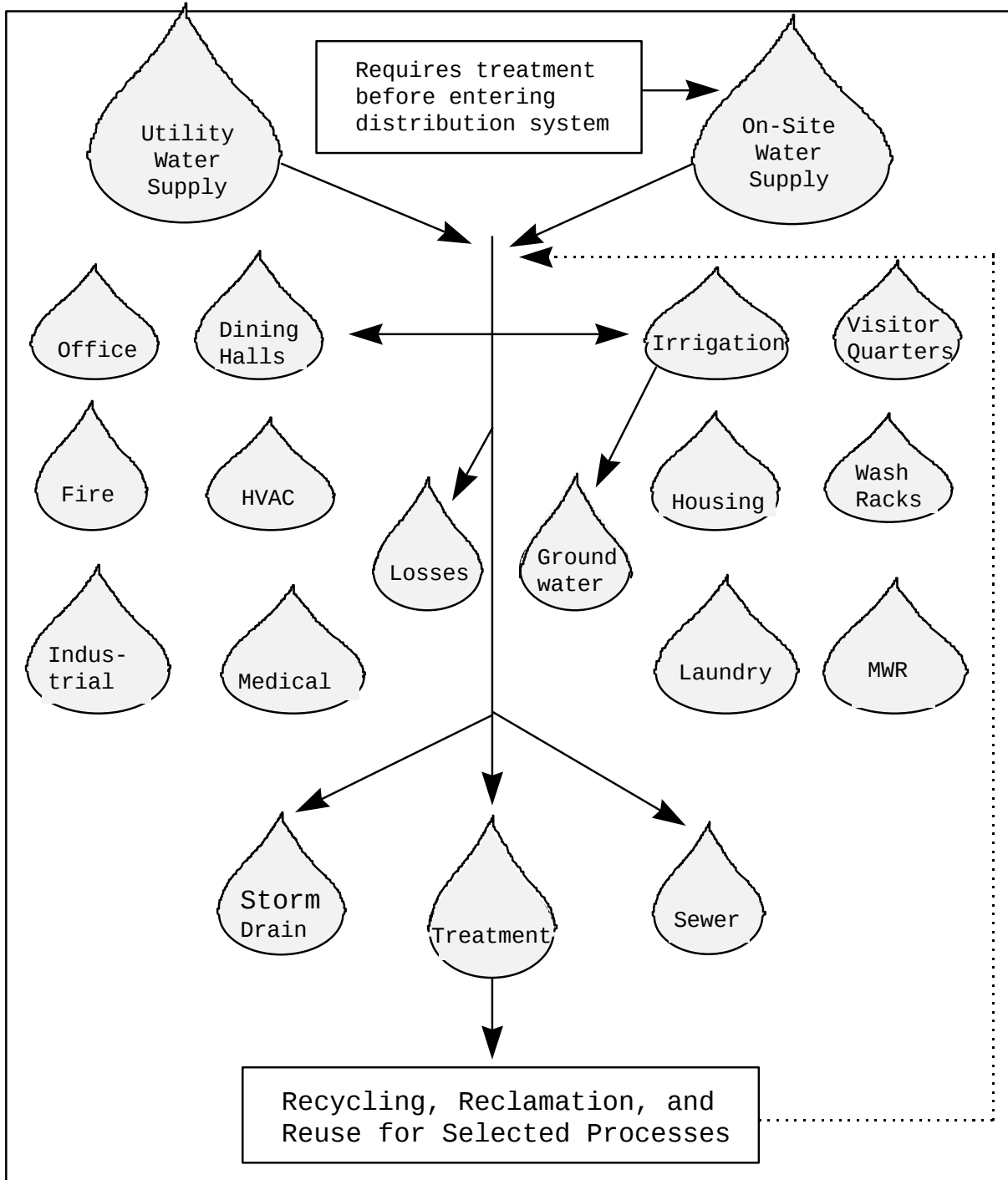

Figure 3  
Typical Water Use at Military Installations

Where does all this water go? What share of this half a trillion gallons is your base using? Figure 3 shows some different uses of water at typical military installations. In order to be able to conserve water, you must know how much you are using and where. This may not seem like a difficult task, but without water meters on the specific usage you are usage increase. This increase could be totally unrelated to the conservation measure (which could have indeed saved water), but investigating, it can be. The worst thing you can do is implement some measure to conserve water only to have your water without a meter to prove the savings (and where the water usage increase really occurred) it may look as though your efforts have backfired. This, in turn, could make it that much more difficult to implement any future water conservation measures at your installation.

With the enactment of EO 12902 and its preceding congressional laws, as well as the realization that fresh water is a precious and limited resource, the implementation of the principles of water conservation at your facility will become part of your regular facility management routine.

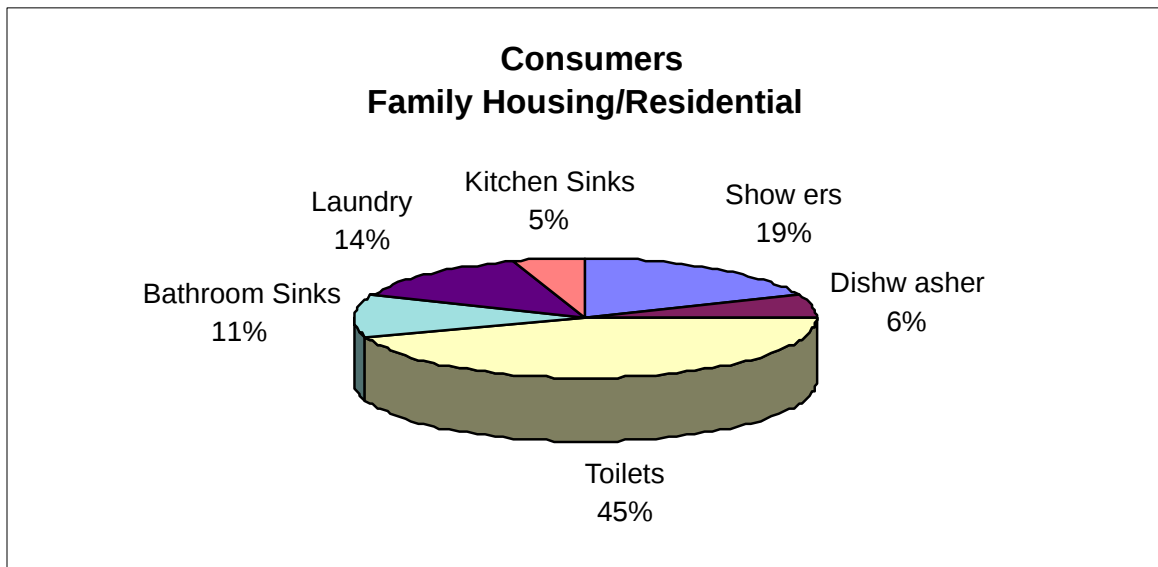

Figure 4  
Typical Water Usage in Family Housing

2.4 Typical Water Uses. Figures 4 and 5 show a typical breakdown of water consumption for residential houses and office/administration buildings, respectively. These particular percentages represent water usage for the city of San Jose, California, but should closely resemble water usage in most locations. Ordinarily, military installations will have a majority of residential or administrative buildings. Notice that for both, the largest use of water is for personal hygiene, specifically, bathroom and restroom usage. These areas should therefore be the first targets for water conservation. Other areas ripe for conservation include landscaping, cooling and heating equipment, and laundries.

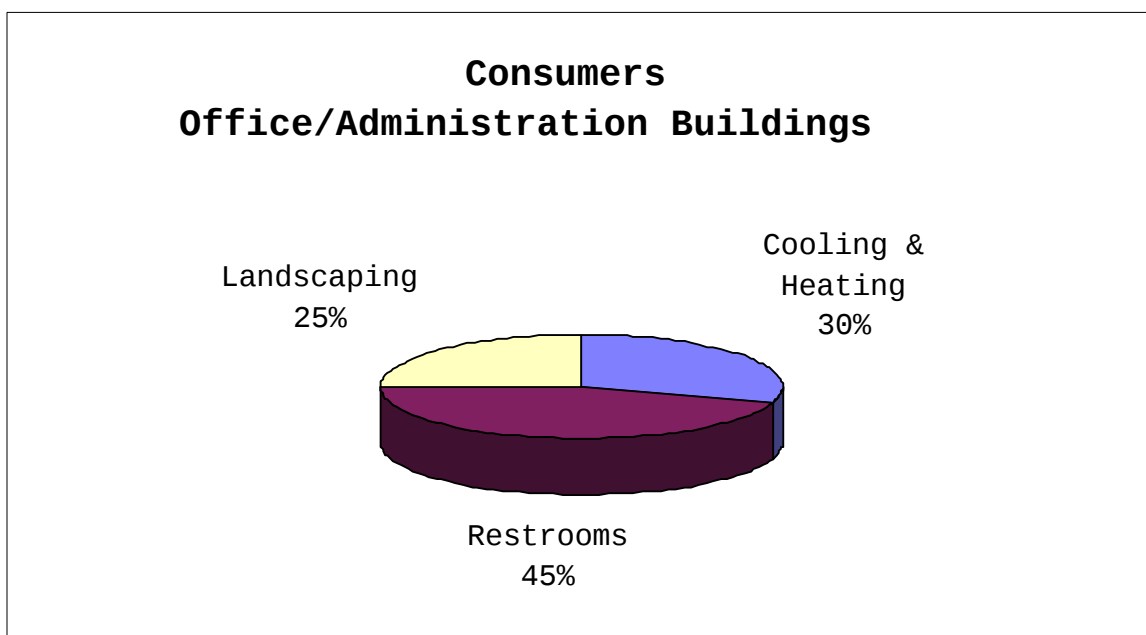

Figure 5  
Typical Water Usage in Office/Administration Buildings

2.5 Typical Water Abuses. Other than concentrating immediately upon your plumbing fixtures, many installations can find significant water savings in other areas. Cooling systems that are once-through systems, where the water is passed through the system once and then straight to the sewer, are extremely wasteful, costly, and in use throughout the military as well as private sector. Freeze protection systems, in many cases,

consist of simply turning on the water and letting it flow throughout the winter. Over watering of landscaping (and concrete) is an ever present concern, and leaks in system distribution, and plumbing fixtures can account for up to 20 percent of your annual consumption.

2.6 Water Costs. Besides knowing where and how much water you use, you must also know how much that water is costing you. Figure 6 shows a compilation of water costs at several different bases. Are the numbers surprising? How much does your water cost? If you pump from your own wells, is it free? If you purchase from a utility company, is the amount of that bill your total water cost? No.

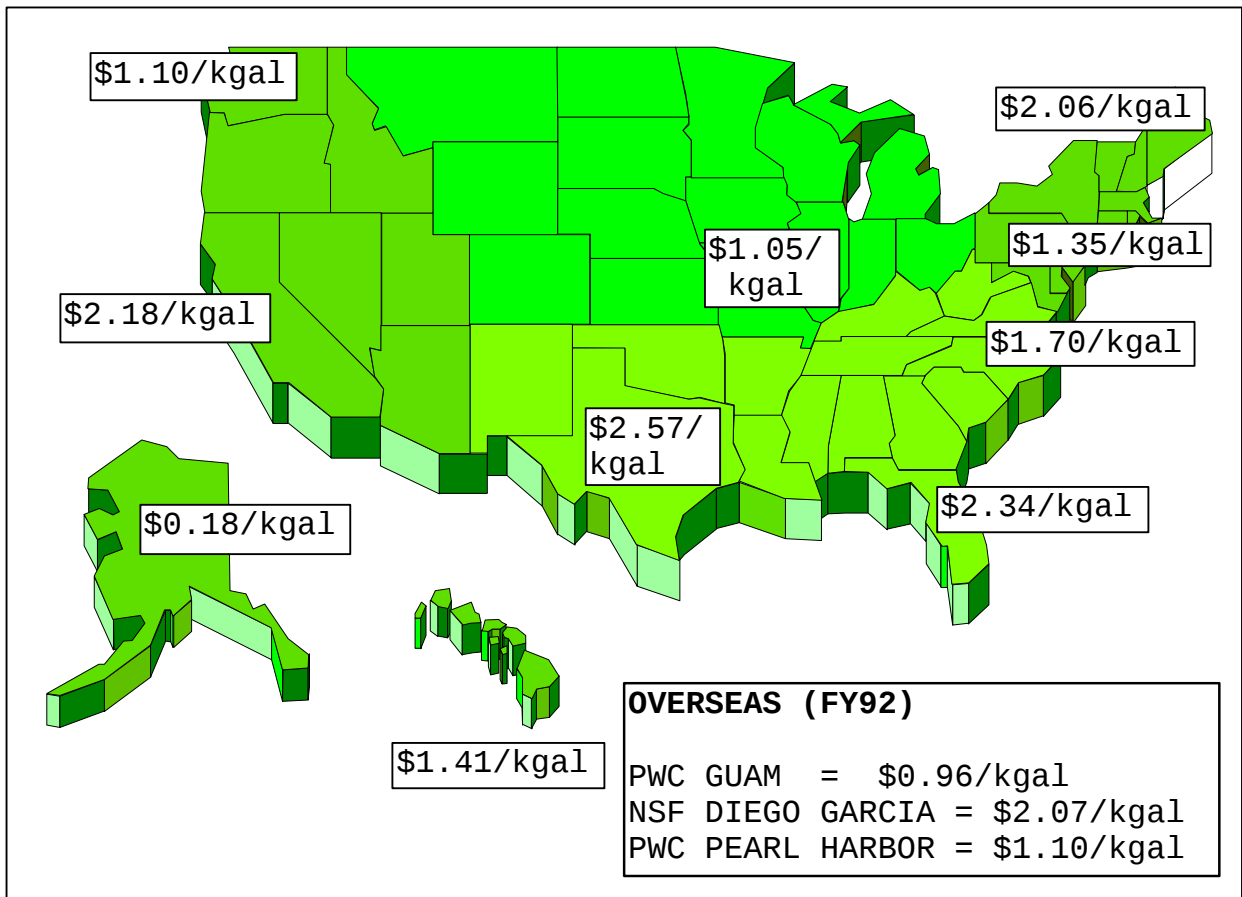

Figure 6  
Average Cost of Water (FY 93) for Selected Sites

2.6.1 Total and Marginal Costs of Water. Many expenses encompass your total water cost, however, only certain costs can be used to document savings on a DD 1391 project submission. These costs are your marginal or variable costs. Basically, the additional costs to produce one more unit of water, or the amount of money that will be saved by reducing your usage by one unit of water. Figure 7 contains a number of costs associated with water production and distribution categorized as a marginal or total cost item.

ITEM	TOTAL COST	MARGINAL COST
Cost to operate wells (for local production wells)	X	
Commodity cost (if purchased from utility company - e.g., the "water bill")	X	X
Cost to treat water (chlorine, electricity, etc.)	X	X
Cost to pump/distribute water	X	X
Labor costs to operate treatment plants	X	
Labor and maintenance to maintain distribution system	X	
Sewage treatment costs	X	X (Note 1)
Disposal costs	X	X
Permitting fees	X	
Water quality testing	X	
<p>NOTE 1: Sewage treatment costs can only be added to your marginal cost if the water conservation measure will reduce the total flow to the sewage treatment plant. Examples:</p> <ul style="list-style-type: none"> <li>a) a conservation measure reducing the amount of water used for irrigation.</li> <li>b) a conservation measure to install low flow plumbing fixtures.</li> </ul> <p>Sewage costs could be considered as part of your marginal costs in example B above, but not in example A because example B reduces the overall flow to the sewage treatment plant while example A does not.</p>		

Figure 7  
Marginal Costs and Total Costs of Water

### Section 3: WATER CONSERVATION PLANNING

3.1 Developing a Water Conservation Plan. Presented below are steps for the development of a water conservation plan. For an in-depth discussion of water conservation programs, refer to Evaluating Urban Water Conservation Programs: A Procedures Manual (refer to references). Following these steps will assist you in complying with the requirements of Executive Order 12902, as well as introducing your facility to the long-term benefits of water and utility savings and efficiency.

3.1.1 Step 1 - Analyze Water Usage. The first step, as discussed earlier, is to determine where and how much water is used on your installation. The method used to accomplish this is the facility water audit, or simply "water audit."

3.1.1.1 The Prioritization Survey. The facility water audit should not be confused with the "prioritization survey" described in EO 12902. The EO 12902 prioritization survey is performed at the agency level. It is an assessment of the overall picture of water use and losses within DoD. It targets installations for further investigation, and establishes highest priority facilities for comprehensive audits. The water audit, on the other hand, is a detailed study conducted at the facility level and is specific for that facility.

3.1.1.2 The Facility Water Audit. A comprehensive facility water audit is the process by which all water-consuming equipment at a facility is monitored to determine water usage, water losses, and the costs associated with each. The types and condition of the equipment are also determined. The survey results allow you, the facility manager, to make informed and appropriate decisions about implementing cost-effective water conservation measures. In short, a water audit allows you to identify, quantify, and verify your facility's water use. Besides being a requirement set forth in the Executive Order, an audit is beneficial for determining and reducing water losses, increasing knowledge of the facility's distribution system, and achieving financial savings. Figure 8 shows the general parts of a water audit.

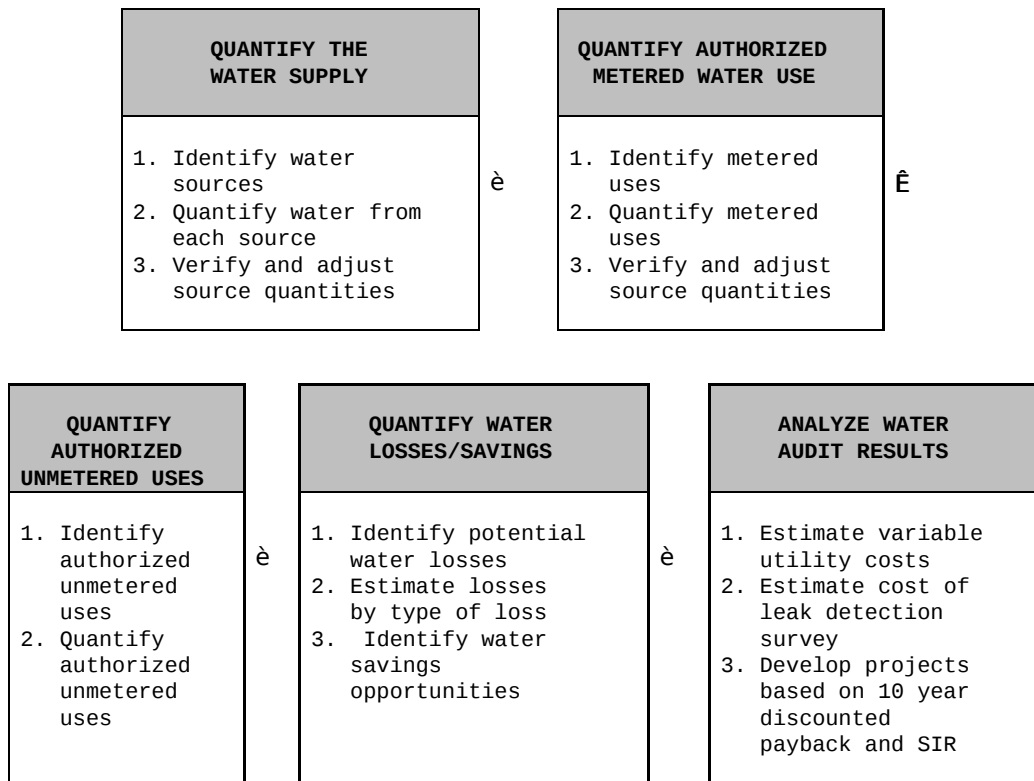

Figure 8  
General Parts of a Water Audit

Conducting an audit of one's facility is a significant undertaking involving the need for labor, time, and materials. There are many tasks that must be performed to obtain meaningful data about a facility's water use. You may wish to obtain assistance from the utility company or an Architect and Engineering (A/E) firm. A series of Water Conservation Survey forms, which will help you organize your audit information, have been developed by the Naval Facilities Engineering Service Center and can be located in Appendix B.

a) Gather Existing Information. The following information should be obtained:

(1) Any maps or floor plans showing plumbing or equipment locations.

(2) Past water and sewage bills from the utility, as well as the identity of the utility.



(3) Any previous water conservation measures (such as retrofits) already implemented; also any previous water audit data.

(4) List of current water-using equipment, their manufacturers, and number of each (e.g., toilets).

(5) Number of employees, their working schedules, and building locations.

b) Conduct the Audit. After the above data has been gathered, the actual audit must be performed. This includes the following steps:

(1) Assemble qualified personnel for a survey team and assign the tasks.

(2) Seek the assistance from the utility - they may be able to help conduct the audit.

(3) Choose the appropriate unit of measure for each device and have survey personnel use it consistently in any calculations (e.g., gpf - gallons per flush for toilets; gpm - gallons per minute for faucets).

(4) Measure incoming water supply flows (it may not match the utility's figures).

(5) Measure outgoing water flows, if possible.

(6) Physically observe and identify all water consuming equipment. Determine their daily usage rate.

(7) Determine the amount of water consumption for each device during use. Use meters as appropriate.

(8) Use leak detection program to determine water losses.

(9) Identify any other observable losses of water.

c) Analyze Audit Results. After completing the water audit, the results must be analyzed to determine where the best water conservation opportunities exist. This includes the following:

(1) Compare the measured water consumption (per use and daily consumption) of the devices to any available manufacturers' claims.

(2) Calculate the cost of the water consumed by each device at the facility and the cost of "lost" water.

(3) Identify recoverable leakage and any corrective measures for them.

3.1.2 Step 2 - Develop Water Use Forecasts. Based on the information obtained from the water audit, water usage into the future should be estimated. This will help drive home the need for conservation, especially if you are at or near your supply's capacity. Numerous methods exist to forecast water usage. These methods could include considerations for any one of a number of things, such as historical demand, seasonal weather, seasonal population, number and types of houses and buildings, weather conditions and much more. Installation Water Resources Analysis and Planning System (IWRAPS), developed for each service, is one software program that could be used to forecast your water usage. Details on IWRAPS and other software programs can be found in Section 5. Regardless of method chosen, you should ensure that any forecasts are consistent with your existing Base Master Plans and Capital Improvement Plans maintained by your base planning office.

3.1.3 Step 3 - Explore Options. Next it is time to examine potential water conservation measures for your installation. There are several issues that should be addressed when one considers which options are suitable for implementation:

3.1.3.1 Long Term -vs- Short Term Reliability. Consider how long the conservation measure will remain reliable. Short term approaches may not be cost-effective in the long run.

3.1.3.2 Capability-Building. Consider adding programs as they become more economically attractive, that is, as they become cost-justified. Do not try to implement every technique right away if it is not cost-effective or environmentally necessary to do so.

3.1.3.3 Avoid Lost Opportunities. Make sure to implement enough of the right measures when the chance arises. Develop a list of potential conservation measures so that when they become

feasible, or when money becomes available, the right measures can be implemented.

3.1.3.4 Social Acceptability. Social acceptance is probably the most important aspect to consider. If the base personnel will not accept it, it is not going to work! Social acceptance increases with overall awareness, another good reason to ensure that base personnel awareness and information is an integral part of your conservation program. Alternate days for watering might not be readily accepted, but if the base personnel are informed and knowledgeable about the installation's water resources, the chance for acceptance will be greater. Acceptance is a major issue with water reclamation projects. The use of "sewage water" for anything except disposal tends to concern many people, unless properly informed of the benefits and safety of such systems. If you are contemplating any water reuse application, the Environmental Protection Agency's (EPA's), Manual EPA/625/R-92/004, "Guidelines for Water Reuse" is an invaluable resource.

3.1.4 Step 4 - Analyze the Benefits and Costs. The costs and benefits of the potential water conservation measures should now be quantified. It cannot be over emphasized that this is one of your key roles as the energy or facilities manager. Not every idea is going to prove beneficial at your particular installation and some, which may not be beneficial elsewhere, will be beneficial for you. More information on identifying the costs and associated benefits of water projects can be located in the reading selections listed in Section 7.3.

3.1.4.1 Costs. What are the new costs associated with the proposed conservation measure? Is new maintenance required, additional personnel, or are significant administrative costs associated with it? These questions need to be considered, in addition to the typical project costs such as parts and labor, prior to implementing any conservation measure.

3.1.4.2 Benefits. What are the benefits of the new water conservation measure? This is where knowing the total and marginal costs of your water are really important. Consider if reductions from your peak demand could eliminate some charges from your water bill, provided you are billed in that fashion. Remember that reduced demand could result in the removal of an existing well from service. Also, if a reduction in your water demand would delay or possibly even eliminate the need for expanding your water or sewage treatment plants, it should be considered. (NOTE: Construction cost avoidance should be

considered, but it cannot be used in FEMP payback computations.) Other possible benefits could include reduced sewage treatment costs (low-flow fixtures), reduced operations and maintenance costs (Xeriscape or automated controls) or even reduced water heating costs (low-flow showerheads).

3.1.5 Step 5 - Develop A Long-Term Plan. After having completed all of the above, it should be fairly simple to incorporate those results into a comprehensive plan to manage your water resources.

3.2 Drought Management Plan. A part of your overall water conservation plan is your drought management plan. A drought management plan will aid you in being proactive when drought conditions begin, rather than just being reactive and hoping for the best. The American Water Works Association (AWWA) "Drought Management Planning" manual contains a detailed discussion of the steps in planning and implementing a drought management plan.

3.3 Public Education and Involvement. Another aspect of water conservation planning is public education and involvement. Without the involvement of the base personnel, water conservation plans of any kind will be difficult to implement. Many of the methods to reduce water usage involve modifying personal habits and behaviors. You can install many water reducing devices, but if the users still take half-hour showers and water their lawns (and sidewalks) throughout the night, your water conservation program will not be very successful. Check with your local water utility, odds are that they already have some form of a public education or information program you can use to base your plan upon. Along with assistance in the public education arena, your local water utility can assist you in other areas - get them involved. Typical services your utility might provide include:

- a) Rebates for equipment retrofits or replacements.
- b) Information on water-efficient equipment and landscaping.
- c) Assistance with water audits and surveys.
- d) Assistance in leak detection.
- e) Metering and metering data.

f) Rate structures, such as tiered, seasonal, excess use, goal-based, or time-of-day.

3.3.1 Public Information. The average resident or employee on your installation has very little knowledge about your water cost or usage. Getting their attention, educating them, and getting their commitment to assist in saving water is critical to a successful water conservation program. "Water Conservation," by Maddaus (refer to references) contains a number of strategies to accomplish this. Briefly, this involves developing a theme for your water conservation program such as "Use Water Wisely," or "An Oasis Needs Water, Save It." Then you need to target your audience: in-school education for children, bulletin boards in the work spaces of your biggest water users, newspapers, radio or television for family housing occupants. There are many ways to get the message of water conservation out to the employees and occupants of your installation, but remember your approach needs to be structured and have the support and attention of the entire chain of command. A successful base personnel awareness program could achieve about a four percent reduction in your water usage.

Section 4: WATER CONSERVATION OPTIONS: SUPPLY

4.1 Introduction. Installing low flow plumbing fixtures and limiting shower times are classic water conservation measures that easily come to mind when discussing water conservation, but you can begin conserving water long before it ever reaches the consumers.

4.2 Water Wells and Treatment Plants. Water wells and water treatment plants are at the head end of most water systems. If these are operated inefficiently or not well maintained, then water is probably being wasted. Reducing excessive backwashing, well discharges, and leaks will reduce the total demand on your water source, and has the same effect as reducing water usage anywhere within your system. MIL-HDBK-1164, "Maintenance and Operation of Water Supply Systems," contains detailed discussions on proper procedures for water treatment plants and wells.

4.3 Leak Detection Programs. After the water is treated, it travels through your water distribution system to the end user. If your distribution system contains leaks, then once again water is being wasted before it ever reaches its intended purpose, and remember: every end use is connected to this distribution system in some manner. Therefore, an important part of your water conservation program and efforts should revolve around leak detection. AWWA's Manual M36, "Water Audits and Leak Detection", contains a detailed write up on the factors to consider and investigate in order to determine if a leak detection program will be beneficial at your installation.

If you are located at an average military facility (circa 1940's) then the odds are pretty high that, as you read this manual for the first time, upwards of 10 percent of your total water production (or purchases) is being lost to system leaks. Leak detections performed by the Naval Facilities Engineering Service Center at several Navy and Air Force installations have found leakage of up to 20 percent of total production.

4.4 Metering. Metering your distribution system will help you determine where your major water users reside, and can help in detecting leaks before ancillary damage, such as road washouts or sinkhole formations, can occur. AWWA's Manual M6, "Water Meters - Selection, Installation, Testing, and Maintenance", contains detailed information on water meters. The Army has also published ETL 1110-3-465, "Design and Construction of Water

Meters and Appurtenances at New Army Facilities." This information will prove helpful once the decision to install a meter has been reached. But, with the current costs associated with installing, and then consistently reading water meters, many activities have decided against the installation of meters.

Studies have shown that water usage is reduced once meters are installed. Call it a phenomenon of "big brother watching" or whatever, but once occupants know how much water they use and can be shown how much they use, their incentive to conserve water increases. Studies conducted from 1955 to 1975 showed reductions ranging from 13 percent to 45 percent after the installation of meters. Further studies in Denver from 1980 - 1982 revealed a 20 percent reduction in water usage between metered and unmetered houses within the same subdivisions.

These results were achieved in the private sector with paying customers. It is doubtful that meters alone will reduce water usage, but if you can attach a bill to the measured water, then these results may be achieved. Therefore, unless you have paying customers (tenant commands, contractors, etc.) meters may not prove to be beneficial. Metering every housing unit for example, would be extremely expensive and would probably achieve no reduction in water usage. However, if you were to meter a paying tenant command who currently is using 30 percent of your total water supply, then reductions could be realized.

4.5 Pressure Reduction. Water savings can be obtained through water pressure reduction. Your water system should be operating at around 50-60 pounds per square inch (psi) (345-414 kiloPascals (kPa)). If your pressure is much higher, then reducing water pressure may create savings.

Section 5: WATER CONSERVATION OPTIONS: END USE

5.1 Introduction. This section includes a wide variety of end use water conservation options. Each option is presented as an operation and maintenance procedure, a retrofit, or a replacement, as appropriate. Some of these options are simple "low cost or no cost" methods such as fixing leaky faucets, reducing excess water pressure, repairing toilet valves, or educating building occupants about proper use of water-conserving equipment. Other options require more extensive retrofitting or replacement.

By no means does this listing include every available water conservation option, and not all the options expressed in this section will necessarily conserve water at your installation. They are listed here for informational purposes on some of the many methods currently in use to conserve water. It is up to you to determine which options are right for your facility, taking into account the information presented here, and factors relevant to your facility. Furthermore, it is recommended that you periodically review the conservation work performed by the Department of Energy. The FEMP Newsletter is a good source for the latest technological advances in energy and water conservation.

5.2 Office Facilities and Residential. The Energy Policy Act of 1992 contains strict water consumption limits for several newly manufactured commercial plumbing products. As of January 1, 1994, all new toilets must use no more than 1.6 gallons per flush (gpf) or 6.0 liters per flush (lpf), all new urinals no more than 1.0 gpf (3.9 lpf), and new shower heads and faucets no more than 2.5 gallons per minute (gpm) or 9.5 liters per minute (lpm). Figure 9 shows a comparison of water usage rates of these conserving devices and their traditional counterparts. Notice the dramatic difference between plumbing devices manufactured before and after 1994. Traditional and conserving toilets, urinals, showerheads, and faucets, as well as other water consuming products found inside office and residential facilities are discussed below. See Figure 10 as you read and note the potential water savings realized from implementing some of the presented options.



MIL-HDBK-1165

Device	Average Flow Rate		Potential Consumption Savings	
	Gallons (Per Flush)	Liters (Per Flush)	Gallons (Per Person/Per Day)	Liters (Per Person/Per Day)
Traditional Toilet	3.5-7	13-26.5	-	
Ultra-low Flow Toilet	1.6	6	8-22	28-82
Traditional Urinal	1.5-3	5.7-11.4	-	
Ultra-low Flow Urinal	1	3.9	1.5-6	6.23
Waterless Urinal	0	0	3-12	11-45
Toilet Displacement Device	Varies		2**	7.6
Toilet Damming Device	Varies		4**	15
	(Per Minute)		(Per Person/Per Day)	
Traditional Showerhead	3-8	11.4-30	-	
Low Flow Showerhead	2.5	9.5	2-27	7.6-102
Showerhead Restrictor Device	Varies		3.7**	14
Traditional Faucet	3-7	11.4-26.5	-	
Low Flow Faucet	2.5	9.5	2-18	7.6-68
Faucet Aerator			0.5**	1.9
	(Per Load)		(Per Person/Per Day)	
Traditional Dishwasher	9-12	34-45	-	
Low Flow Dishwasher	5-9	19-34	1.0**	3.9
Traditional Clothes Washer	35-55	132-208	-	
Low Flow Clothes Washer	20-30	76-114	1.7**	6.4

Toilets: Assume 4 flushes per day per person  
 Showerheads: Assume 5 min/day shower per person  
 Faucets: Assume 4 min/day running faucet per person

\*\* From "Water Conservation", AWWA, 1987.

Figure 9  
 Potential Water Savings for Various Plumbing Fixtures

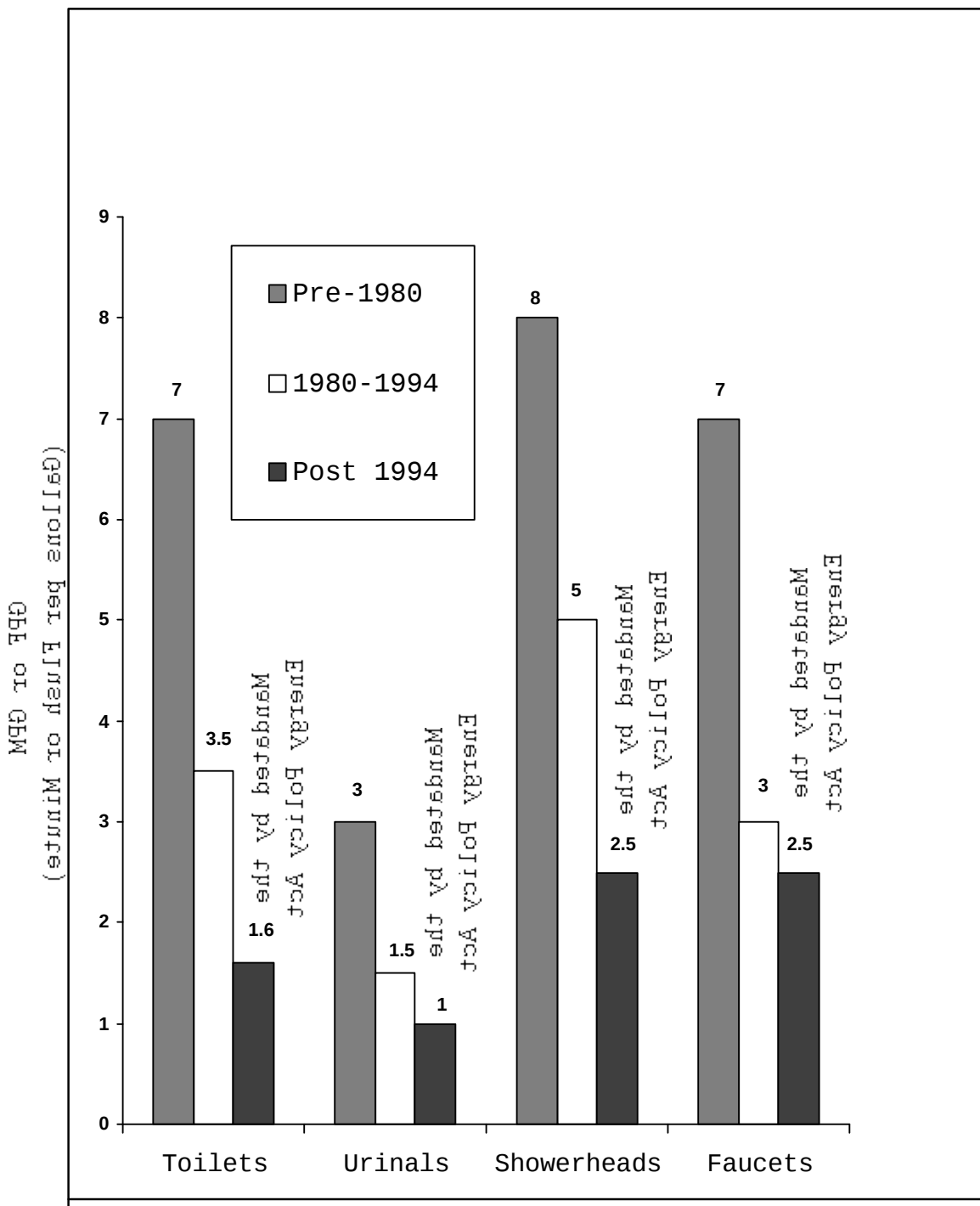

Figure 10  
Water Usage Rates of Bathroom Plumbing Fixtures

## 5.2.1 Toilets

5.2.1.1 Conventional and Water-Efficient. Toilets account for approximately 45 percent of indoor water use (Figure 4), making them a prime candidate for water conservation measures. The most common types of toilets are the gravity flow toilet, flush valve toilet, and pressurized tank system.

a) Gravity toilets. Gravity toilets work by using a tank of water and a rubber stopper. The water is released by the stopper and enters or "flushes" into the bowl from the tank by gravitational force.

b) Flush valve toilets. Flush valve toilets have no tanks. Instead, pressurized water pipes are activated by valves to release water at specific flow rates into the bowl. Typically, gravity flow toilets are seen in residential buildings, and flush valve toilets in office and administration buildings.

c) Pressurized tank toilets. Pressurized tank toilets are a newer design of the old tank toilet and are made to use 1.6 gpf (6.0 lpf) or less. Here, an air bag in the tank exerts pressure on the water to force it down into the bowl. "Blowdown" toilets are pressurized tank toilets with the tank hidden behind the wall.

d) Traditional toilets. Traditional toilets (manufactured before 1980) are primarily gravity flow or flush valve and use 5 to 7 gpf (19 to 26.5 lpf). Since 1980, low flow toilets using 3.5 gpf (13 lpf) and ultra low flow (ULF) toilets using 1.6 gpf (6 lpf) have been introduced into the marketplace. Unless your facilities have been renovated or newly built since 1980, it is likely that you are currently using high-flow toilets, and wasting significant amounts of water. Replacing a conventional toilet with a 1.6 gpf (6 lpf) toilet can reduce toilet water usage by as much as 70 percent per day! Although not as effective as replacing a conventional toilet with an ULF, operation and maintenance procedures and retrofitting can reduce the amount of water your existing toilets use and make them more efficient. However, some retrofits may require frequent adjustment or maintenance and may interfere with the proper operation of the toilet, which was not designed to work with low volumes of water.

5.2.1.2 Operation and Maintenance Procedures. Listed below are some maintenance procedures that will conserve water in conventional toilets:

a) Locate and repair leaks. This is an important procedure! Huge amounts of water are wasted from leaky toilets and faucets. (See Figure 11.)

b) Replace worn parts if practical (e.g., rubber stoppers, valves, ballcocks).

c) Adjust valves to more efficiently control water flow.

Intensity	Amount of Water Lost	
	<b>Faucet Drips and Leaks</b>	
	<b>(gpd)</b>	<b>(lpd)</b>
Slow	36	136
Steady	180	681
One quarter open	664	2513
One-half open	1620	6132
Full open	3600	13626
	<b>Toilet Leaks</b>	
	<b>(gpd)</b>	<b>(lpd)</b>
Seeping	30	114
Constantly Running	6000	22710

Note: gpd = gallons per day, lpd = liters per day

Figure 11  
Water Lost Through Leaks

5.2.1.3 Retrofits. Listed below are some suggestions for toilet retrofitting:

a) Displacement devices for gravity flow toilets - bags or bottles of heavy material which displace water in the tank, resulting in less water entering the bowl during or after each flush.

b) Damming devices for gravity flow toilets - flexible inserts which partition the tank and prevent some of the water from leaving the tank during a flush, resulting in less water entering the bowl.

c) Early-closure devices - restrictors at the flush valve, or new reduced-flow flush valves that save water by causing the valve to close early, reducing the amount of water used for flushing.

d) Weighted flappers - cause the flush handle to release early to shorten the flush duration, thereby saving water.

e) Dual-flush devices - dual flush handles that allow a minimal flush by moving the handle one way and a maximum flush by moving the handle the other way.

f) Flow diverters - diverts, into the tank, a portion of the water that would otherwise go through the overflow tube (gravity flow).

g) Flush valve retrofits - several commercial products exist which can increase the efficiency of the toilet flush valves.

5.2.1.4 Replacements. New gravity flush, flush valve, and pressurized-tank toilets are designed and manufactured to comply with the Federal requirement of 1.6 gpf (6 lpf). Variations of these designs include shallow trap toilets and compressed air toilets, and are available from many vendors. These toilets can be designed to look like traditional toilets.

Waterless toilets are also commercially available, although not nearly as common as the three types above. They are more costly to obtain and maintain, and are generally used in areas where water is scarce. Oil, composting, or incineration are some of the methods by which these toilets eliminate waste.

5.2.1.5 Problems and Pitfalls. As stated above, certain retrofits may adversely affect the performance of some toilets and may require frequent adjustment or repair. For example, take care not to choose displacement devices that eventually will crumble apart in the tank, such as bricks. Some retrofits are also expensive and time consuming to install (e.g., dual-flush

devices). You should be aware of and prepared for these possibilities if you decide to retrofit.

Concerning replacement, ULF toilets are not all alike. Some brands outperform others. ULF toilets may require more frequent cleaning; some may not flush waste as efficiently as others, resulting in more flushes per use; and some may not provide sufficient "scour" velocity to the sewage lines to carry away the waste, resulting in increased sewage maintenance.

Overall, however, the most recent ULF toilets are more technologically advanced than the first ones to appear on the market a decade ago. With a little product research, quality ULF toilets can be obtained which have no more operating problems than conventional toilets.

## 5.2.2 Urinals

5.2.2.1 Conventional and Water-Efficient. Conventional urinals utilize from 1.5 to 3.0 gpf (5.7 to 11.4 lpf). New urinals, in compliance with federal regulations, use a maximum of 1.0 gpf (3.9 lpf). Savings of 1.5 to 6 gallons (6 to 23 liters) per day per person can be realized by using ULF urinals. Urinals come in a variety of designs and may be floor- or wall-mounted.

a) Siphon jet urinals. Siphon jet urinals are the most common type of urinal. They use a tank and a siphon device that discharges the flush tank when the water level in the tank reaches a certain height. There is no user-controlled flushing mechanism. Siphon jet urinals are appropriate for high traffic lavatories.

b) Washdown or washout urinals. Washdown or washout urinals use a mechanical flush handle or button (user controlled) to activate the water to wash down the basin, carrying the liquid waste with it. These urinals are generally used in low traffic lavatories.

c) Blowout urinals. Blowout urinals work in a similar way to siphon jet urinals, except that the tanks are concealed behind the wall.

d) Waterless urinals. Waterless urinals work by using special trap inserts containing a biodegradable liquid. The liquid has a lower specific gravity than urine and floats on the surface of the trap as the heavier urine passes through to the

sewer line. This prevents odors from permeating to the air above. Also, the urinal bowl is usually coated with a water and urine repellent material that prevents bacterial growth and odors. The trap is removed and replaced periodically. Manufacturers' claims indicate that the waterless urinals have substantially lower operating costs than flush type urinals, as well as increased water and sewage savings.

The waterless urinal is an approved fixture in the 1996 National Standard Plumbing Code and complies with ANSI Z124.9-94. They are also very cost effective for new construction projects since water supply and flush valves are not needed. Care does need to be taken however to prevent the waterless urinals from becoming scratched, as scratches will damage the urine-resistant coating that can cause urine to "stick" and dry on the urinal's surface.

5.2.2.2 Operation and Maintenance Procedures. Listed below are some maintenance procedures that will conserve water in conventional urinals:

a) Locate and repair leaks.

b) Replace small parts, if practical to do so. Siphon jet urinals, for example, use rubber diaphragms that should be replaced periodically.

5.2.2.3 Retrofits. Listed below are some suggestions for urinal retrofitting:

a) Flushometer valves - fit conventional urinals with water-reducing parts.

b) Timers - install on urinals that have constant water flow to turn the water off during no-occupancy hours.

c) Sensors - install to automatically flush after urinal is used, preventing the user from over-flushing.

5.2.2.4 Replacements. The 1.0 gpf (3.9 lpf) urinals come in the types listed above and are available from a multitude of vendors. Waterless urinals (described above) are also available.

5.2.2.5 Problems and Pitfalls. Fewer difficulties should result from retrofitting or replacing urinals than from toilets because of the less complex nature of the waste. However, you

should monitor the updated urinals to make sure the waste is being sufficiently flushed, and that users are not throwing foreign matter such as cigarettes or paper into the bowls. Waterless urinals should not be installed if your sanitary sewer piping consists of copper or copper fittings. Copper corrodes much faster with the higher urine concentrations found with waterless urinals.

### 5.2.3 Showerheads

5.2.3.1 Conventional and Water-Efficient. Although showerheads are found mainly in residential housing units, many installations have showers in employee and resident recreational facilities as well. Conventional, obsolete showerheads typically use 5-8 gpm (19-30 lpm) at 80 psi (550 kPa) when new. As they age, the flow rate may decrease to 3-4 gpm (11.4-15 lpm) due to corrosion and hard water deposits.

New low-flow showerheads use 2.5 gpm (9.5 lpm) or less at the same pressure. Installing these high-efficiency showerheads can result in savings of approximately 2-27 gallons (7.6-102 liters) per five-minute shower, plus energy savings due to less demand for hot water. High-efficiency showerheads are relatively inexpensive, costing anywhere from \$5-100. They are also simple to install. Many good models are under \$20 and bulk-buying can greatly reduce the unit price.

5.2.3.2 Operation and Maintenance Procedures. The following procedures may be applied to high-efficiency showerheads as well as conventional ones:

- a) Locate and repair leaks,
- b) Encourage shorter showers.

5.2.3.3 Retrofits. Although not nearly as effective as replacement, retrofits can be used on the existing showerheads if funds are not available to replace them with high-efficiency units. Typical retrofit options include:

- a) Pressure reduction valves reduce water pressure to the shower which reduces the amount of water flow.



b) Shut-off valves allow you to turn the water off while soaping up, then on when rinsing. These can be used with high-efficiency showerheads as well.

c) Flow restrictors are special washer devices with a center hole that reduces water flow when placed inside the showerhead.

5.2.3.4 Replacements. Many brands of high-efficiency, low-flow showerheads are commercially available and come in many shapes and sizes. There are three basic designs by which these heads deliver water:

a) Aerating. "Aerating" showerheads work by drawing air into the flow of water producing fine water droplets over a larger surface area.

b) Atomizer. "Atomizer" heads mist the water and deliver it in extremely fine droplets over a large surface area.

c) Pulsating. "Pulsating" heads cause the water to be delivered in pulses alternating between high flow and mist. Some showerheads have adjustable flows which can change the water delivery from pulsating to mist.

In any case, the latest technology allows high-efficiency showerheads to provide as "satisfying" a shower as the conventional types while still conserving water.

Consider, also, installing the showerhead as a hand held unit instead of a fixed-in-place model. Shower users may decrease their amount of shower time with a hand held head because of the ability to precisely direct the spray, thereby reducing rinse time. Hand held models, however, are at greater risk to be mishandled or vandalized.

5.2.3.5 Problems and Pitfalls. Restrictor retrofits often result in poor shower performance and are not recommended for

long-term conservation. Certain locations, with extremely hard water, cannot use restrictors due to plugging. Shut-off valves may cause temperature differences in the water and could result in scalding when the water is reactivated. The risk of scalding may also increase with low-flow showerheads if plumbing lines do not maintain proper water pressure while nearby toilets are flushed. Lowering the temperature at the water heater and

installing anti-scald valves will help to remedy this. Alternatively, the plumbing itself could be replaced.

User satisfaction with a high-efficiency showerhead depends on how the shower "feels". User satisfaction will generally be low if the chosen heads do not provide adequate wetting ability and perceived water pressure. Some field testing may be needed before a final choice is made as to the exact brand and model that will best suit your facility.

#### 5.2.4 Faucets

5.2.4.1 Conventional and Water-Efficient. Conventional bathroom (and kitchen) faucets use between 3 to 7 gpm (11.4 to 26.5 lpm). New faucets, designed to meet federal codes, use a maximum of 2.5 gpm (9.5 lpm) at 80 psi (550 kPa), although most bathroom types are being manufactured to use 1.5 gpm (5.7 lpm) or less. Assuming high-efficiency faucets are left on for the same amount of time as the conventional types, a savings of 2-18 gallons (7.6-68 liters) per person per day can be realized for each high-efficiency faucet used.

5.2.4.2 Operation and Maintenance Procedures. The following maintenance procedures can be applied to faucets:

a) Faucets should be periodically checked for leaks and repaired as needed. Leaky faucets can waste enormous amounts of water (tens of gallons in a single day).

b) For conventional faucets, water flow can be reduced by adjusting the flow valves if applicable.

5.2.4.3 Retrofits. The following retrofit options may help reduce the amount of water your conventional faucets use:

a) Aerators - a device that uses a screen to mix air and water in the faucet head, giving the illusion that more water is flowing through the faucet.

b) Restrictors - same as for showerheads, they are washers with center holes that restrict the flow of the water through the faucet.

5.2.4.4 Replacements. The new low-flow faucets come in a wide variety of aesthetic styles, but essentially operate in one of two ways: aeration or laminar flow. In laminar flow faucets, the

water travels in parallel streams producing a clear flow of water without being mixed with air (as in aeration). This produces superior wetting ability over that of aerating faucets. Laminar flow faucets are more expensive than aerating types but not extravagantly so.

It is becoming an industry standard to add trickle shut-off valves or levers to faucets. These levers allow the user to shut off the water when performing some task that does not require it, then to turn the water back on at the exact same flow and temperature. The valve prevents the need to turn the faucet off or to readjust the flow and temperature.

Some low-flow faucets are metered-valve type, or self-closing, which will deliver a fixed quantity of water and then shut off automatically. Another type of automatic faucet is sensed. Self-closing faucets work with a spring-loaded lever that slowly returns to its original position and turns off the water. Sensed faucets, either infrared or ultrasonic, are designed to turn on when a user's hands are placed under the faucet, and turn off when the hands are removed.

5.2.4.5 Problems and Pitfalls. Faucet aerators need to be checked periodically for clogging, some models clog more easily than others and may need to be cleaned too often to be effective. Some aerators may cause unacceptable performance or the perception of poor performance, resulting in an increase in water use.

The levers or handles that control the faucets on non-sensing types may also make a difference. Whereas sensed faucets are designed to deliver water at a set volume and temperature, single bar levers on non-sensed faucets tend to

cause the user to use more water than necessary to achieve a desired volume and temperature. Redesigned levers can be purchased which will deliver only a set temperature or even just cold water unless deliberately pushed completely to the left for hot water. Two-handled faucets also precipitate the same problem. Foot-controlled levers for office lavatories may be an alternative to sensed devices and help to prevent the spread of germs. Sensed faucets are usually not appropriate for kitchens due to the need for total volume and temperature control by the user.

5.2.5 Chilled Drinking Fountains and Ice Machines. Chilled drinking fountains and ice machines are not currently covered under Federal regulations, therefore there are no specific conventional versus water-efficient comparisons to be made. However, with proper maintenance you can realize both energy and water savings for these units, whether stand-alone or centrally controlled systems. You might also choose to replace older units with newer, more energy efficient models.

5.2.5.1 Replacements. Water-cooled ice makers can be replaced by air-cooled condenser units. Air-cooled condensers do not require water for cooling. Also, consider replacing a cube machine with an ice flake machine. Machines that flake the ice instead of cube it do not need bleed-off water to carry away visual contaminants from the cubes.

#### 5.2.6 Washing Machines

5.2.6.1 Conventional and Water-Efficient. Current washing machines in family housing units are primarily top-loading, vertical-axis machines that use from 35-50 gallons per load (gpl) (130-195 liters per load (lpl)). Laundromat type washers are front-loading, horizontal-axis machines. These commercial style washers typically use only 25-30 gpl (95-115 lpl), due to the fact that they tumble the clothes on a horizontal axis enabling them to use less water. A third type of washer is a top-loading, horizontal-axis machine that combines the convenience of the top loader while only utilizing around 15 gpl (58 lpl).

5.2.6.2 Operation and Maintenance Procedures. For existing washing machines, the following suggestions will aid in conserving water:

- a) Locate and repair leaks.
- b) Encourage users to wash only full loads.
- c) If water level is able to be set by the user, encourage using only as much water as needed for that load.

5.2.6.3 Retrofits. The only retrofit which can be applied to washing machines is a rinse-water recycling system. Generally, this will only be applied to base laundromats and industrial laundries, rather than residential homes.

5.2.6.4 Replacements. The water-efficient washing machine has not advanced as far as other water conserving devices. There are not many manufacturers of household horizontal-axis washers (front-loading or top-loading). The household front-loader is slightly more expensive than the conventional top-loading, vertical-axis model, but not significantly so, while the household top-loading, horizontal-axis models cost about two to three times more than the conventional machines. Older washers can also be replaced with newer ones that have more options for controlling water levels and temperature.

5.2.6.5 Problems and Pitfalls. As mentioned above, horizontal-axis washers cost more than conventional machines, but can reduce operational costs. Cost savings can be achieved not only in water usage, but also in energy savings due to reduced water heating costs. The horizontal-axis machines also use significantly less detergent. A cost analysis should be performed for your residential facilities to determine if replacing conventional washing machines with horizontal-axis machines will prove beneficial.

#### 5.2.7 Dishwashers

5.2.7.1 Conventional and Water-Efficient. Dishwashers can be classified as residential or commercial. The familiar rack type dishwashers are used in residential households. Commercial type dishwashers are used in cafeteria or restaurant facilities. Commercial dishwashers or "warewashers" are available in a variety of rack and conveyor designs. They are either high temperature-rinse or low temperature-rinse machines, meaning they rinse and sanitize the dishes with either 180 degrees Fahrenheit (82.2 degrees Celsius) or 140 degrees Fahrenheit (60 degrees Celsius) water, respectively. In conveyor dishwashers, the dishes are placed in a tray on a conveyor and passed into the warewasher after manual pre-rinsing. Warewashers use approximately 1-1.5 gpm, (3.8-5.7 lpm) depending on design and features. Conventional older rack washers use between 9 and 12 gpc (gallons per cycle) (34-45.5 lpc (liters per cycle)). Most new residential dishwashers currently sold use between 5 and 9 gpc (19-34 lpc). They incorporate a variety of features that allow them to conserve water, but which are primarily included to conserve energy.

5.2.7.2 Operation and Maintenance Procedures. The following are water saving procedures to implement with existing dishwashers:

- a) Locate and repair leaks in hoses, spray rinse fixtures, etc.
- b) Wash only full loads in residential rack-type dishwashers.
- c) Use minimum flow rates suggested by the manufacturer.
- d) For conveyor types, reduce flow rates for the pre-wash spray, if present, to minimum acceptable levels.
- e) For conveyor types, ensure that the flow of water stops when no dishes are present.

5.2.7.3 Retrofits. The following retrofits can save water with existing dishwashers:

- a) Install pressure or flow regulators to limit flow to the manufacturer's suggested levels.
- b) Equip conveyor types with an "electric eye" to automatically shut off the water unless dishes are present.
- c) For conveyor types, limit or eliminate scrapping troughs (used to carry away food waste in a stream of water to the garbage disposal).

5.2.7.4 Replacements. New rack-type dishwashers include one or more features to aid in conserving water. One feature is an improved spray arm geometry, developed in Europe, which allows water to be sprayed alternately through the top and bottom spray arms, instead of both at once. Less water is used while the wash quality remains the same. Other features include an improved sump fill control that makes use of timers to control the volume of water initially admitted to the dishwasher, and an improved sump geometry that protects the pump (from drawing in air) with a smaller volume of water. Additionally, improved filters and more efficient motors permit enhanced cleaning power with less water.

Newer commercial warewashers also make use of the booster heater. Moreover, since large amounts of water are used in the pre-rinse phase of commercial dishwashing, manufacturers are developing methods and equipment to reduce the amount of water used for this stage. One method is called ultrasonic pre-rinse. As the name implies, the rack of dishes is immersed in a

large tank of hot water with detergent and ultrasonically cleaned (with sound waves) for a specified period of time. Food residue is loosened from the dishes that are raised out of the tank, drained, and sent on to the warewasher. Less water is consumed and the food residue is filtered and dumped into the trash instead of being rinsed into the garbage disposal.

5.2.7.5 Problems and Pitfalls. Today's dishwashers are geared primarily towards saving energy. Research on the many different brands and styles is needed to select one that is also highly water-efficient. Some models are better than others.

Concerning commercial warewashers, the low-temperature rinse units may use less energy but require more water and wash fewer racks per hour than the high-temperature rinse units. They also use more detergent. Some models do not have internal heaters to ensure that the water temperature does reach 140 degrees Fahrenheit (60 degrees Celsius), so the water used may be even cooler than this, depending on the temperature of the incoming water or how long the water sits in the fill tank. Lower water temperatures may lead to less effective rinsing and increased residue on the dishes. This is an important factor in commercial applications where the cleanliness of the dishes is most critical. Gas booster heaters (rather than electric ones) allow high-temperature rinse warewashers to still be energy efficient while (more) effectively cleaning the dishes with less water than a low-temperature rinse washer.

5.2.8 Garbage Disposals. Although newer technology has improved the disposal's waste grinding ability, the garbage disposal's use of water is primarily dependent on the user. Since it is not absolutely necessary to dispose of food waste down the sewer, you may want to consider eliminating garbage disposals in new construction at your facility. This could, however, create dissatisfaction and plumbing problems, as occupants may dislike the inconvenience of not having a garbage disposal and may attempt to use the sink as a food dump anyway.

For existing garbage disposals, public education is the key. Encourage users to utilize the garbage disposal sparingly, and to use only the minimum amount of water necessary to flush the food waste down the sewer. Discourage using the garbage disposal for inappropriate items such as bones, cooking grease, fat gristle, nut shells, etc.

5.2.9 Water Softeners. Water softeners are generally used for hot water applications such as boiler feedwater and bathing. Water softeners are another appliance in which the water use primarily depends on the operator. Consider eliminating water softeners where not needed, e.g., geographical areas where the tap water is not excessively hard, and for applications such as drinking, landscaping, and toilet flushing.

5.2.9.1 Operation and Maintenance Procedures. The following are water saving procedures to implement with water softeners:

a) Set the softener controls to start the softening and regeneration process only when needed.

b) Locate and repair leaks in plumbing connections.

5.2.9.2 Replacements. New softener models may come with water-efficient regeneration cycles.

5.2.9.3 Problems and Pitfalls. Water softeners create calcium sludge when softening hard water, which may adversely affect the outgoing sewer line. Check that your softener units are only running when necessary to reduce the amount of sludge. Using a higher quality softener salt may also help.

### 5.3 Industrial Operations

5.3.1 Washrack Cleaning Facilities. The military maintains numerous facilities for washing and rinsing its aircraft and vehicles. These washrack facilities encompass aircraft, wheeled vehicles, and track vehicles (such as tanks). With so many facilities using large amounts of water on a regular basis, they are an excellent candidate for water conservation.

5.3.1.1 Conventional and Water-Efficient. The categories of wash facilities can be grouped according to the type of wastewater emitted from each. Figure 12 shows five typical washrack groups with corresponding water requirements, typical wastewater quantities. Newer, commercially available washrack equipment will usually include some of the retrofits and recycling options listed below. It is not feasible to give precise water or cost savings for implementing these options, since each facility is unique in its function, setup, and usage rates. It can be said, however, that data collected from Army installations that have implemented these measures indicates water savings of up to 70 to 80 percent have been realized. The



initial capital cost of installing a recycling system can range from approximately \$20K to several hundred thousand, depending on the technology employed.

5.3.1.2 Operation and Maintenance Procedures. The following maintenance procedures can help conserve washrack water use:

a) A periodic check of equipment for malfunctions or leaks is a simple but effective way to conserve washrack water.

b) If detergents are used, use high quality detergents with superior cleaning power. This, combined with good rinsability, will shorten the length of time required to clean each vehicle or aircraft.

5.3.1.3 Retrofits. For existing wash facility equipment, there are several low cost measures that are capable of saving significant amounts of water.

a) Timers - useful in aircraft rinsing facilities, but not for washrack units since each vehicle or aircraft must be washed until sufficiently clean. The timing is different for each run and should not be preset.

TYPE OF FACILITY	WATER REQUIRED PER ITEM		AVERAGE WASTEWATER PRODUCED	
	GALLONS	LITERS	GALLONS	LITERS
Aircraft Rinsing	1000-3000	3785-11350	1750	6625
Aircraft Washrack Platform	(helicopter) 200 (aircraft) 2500-3000	760  9460-11350	(helicopter and aircraft) 2000	7570
Automotive Vehicle Washrack	100-1000 depending on size	380-3785	600	2270
Tracked Vehicle Washrack	1000-3000	3785-11350	2000	7570
Automotive Vehicle Maintenance	same as automotive washrack		same as automotive washrack	

Figure 12  
Washrack Water Requirements

b) Spray apparatus - automatic spray heads are recommended for aircraft rinsing, but not for washing, for the same reason listed above.

c) Automatic shutoff spray nozzles - these devices are designed for facilities with manual rinsing. They are the same basic design as a garden spray nozzle. Considering that water is usually left on during the entire time a vehicle or aircraft is washed and rinsed, the automatic shutoff spray nozzle can save tens to hundreds of gallons per run.

d) Low flow and high pressure hot water units - can reduce the amount of water and solvents used by facilities for cleaning engine components. The standard method for cleaning engine parts has been to use organic solvents or low-pressure cold water. High-pressure hot water greatly reduces the required amount of water and solvents, which may require handling as hazardous waste. Reduction in solvent use also contributes to the installation's pollution prevention goals.

e) Pre-wash areas - for tracked vehicle washracks with recycling systems, to eliminate a majority of the coarse dirt so that it will not enter into and clog up the treatment system.

5.3.1.4 Water Recycling, Reclamation, and Reuse. The costliest, but most highly effective way to reduce water usage at wash and rinse facilities is to implement a wastewater recycling system. The type of wastewater treatment system you choose will depend on the configuration of your facility. Figure 13 shows possible water recycling systems for two common types of automatic vehicle washracks; (1) tunnel (gas station car washes) and (2) rollover. Passing through these systems, treated wastewater is recycled back to the washrack for reuse.

a) Recycling. Remember, the treatment system must be capable of providing water with acceptable quality before it can be recycled. The recycled water's quality depends on what system components are used and the components of the incoming water. The water used on wash racks needs to be relatively free of abrasive materials, oils, or salts that might damage or stain the vehicles you are washing, and it also must be free of chemical or bacterial agents that might harm the operators of the washrack. Wastewater treatment systems are likely to contain the following components: sand traps, oil and water separators, screen filters, coarse/polishing filters, and storage tanks for the treated water.

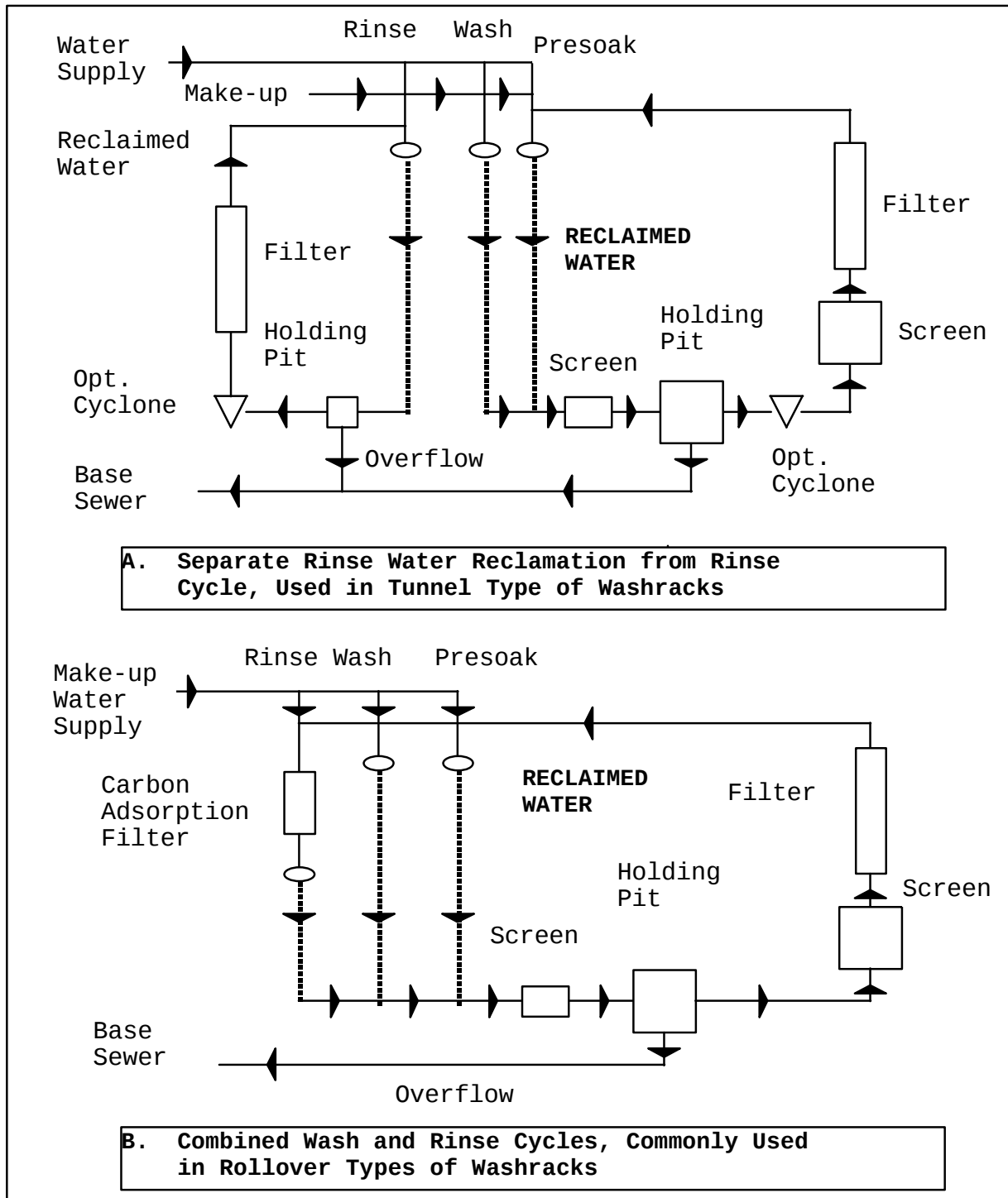

Figure 13  
Two Types of Washrack Water Reclamation Systems

b) Reuse. Water reuse from or to other industrial applications is another alternative. Vehicle washrack effluent may be directly used in metal cleaning and painting applications, depending on its quality, for preliminary or intermediate cleaning and rinsing stages. Water discharged from cooling tower bleed-off or boiler blowdown may be used for washracks after minimal treatment.

c) Reclamation. Treated sewage effluent may also be used but only with proper treatment and should only be used for presoaking or first-wash stages.

d) Retrofits. To determine what retrofit or recycling options are suitable for your facility, you need to collect field data and perform a cost analysis (refer to the "DoD Energy Manager's Handbook" for complete details on developing a cost analysis). The following information will assist you in developing the cost analysis:

- (1) Daily water usage for each facility (use flowmeters to calculate the flow volume).
- (2) Types of equipment used.
- (3) Manpower and time required for each wash and rinse.
- (4) The number of vehicles or aircraft washed daily.
- (5) The quality of your effluent water.

5.3.2 Plating Facilities. The military operates a number of plating facilities that encompass a variety of processes, including hard chrome plating, nickel, zinc, or cadmium plating, etching, and phosphating. Plating is a general term describing the practice of applying a surface coating to a metal or nonmetallic item to impart corrosion resistance, wear resistance, or for decoration. The process of plating involves several steps, including surface preparation, plating, and post-treatment. All of these steps incorporate rinsing procedures to remove residues from the previous step. Rinsing uses a majority of the water utilized in plating operations and is, therefore, the prime target for water conservation.

5.3.2.1 Conventional and Water-Efficient. Conventional plating facilities are those which do not incorporate the retrofit or recycling options discussed below. Typical features of a traditional, water-wasting facility include continuous overflow rinse tanks, contaminated plate bath solutions that are discharged instead of repurified, lack of drip trays or splash guards, short drip times resulting in excessive drag-out of bath contaminants, and overcrowded racks.

As for washrack facilities, it is difficult to predict what the exact water and cost savings will be for your particular facility when you implement the described water conservation measures. However, from the data collected at facilities that have implemented these measures, water savings of approximately 50 to 90 percent have been realized. Using a water recycling and reclamation system also greatly reduces sewage and hazardous waste costs, which can be significant for large-scale plating shops.

5.3.2.2 Operation and Maintenance Procedures. The following are simple, low cost procedures that can save significant amounts of water:

- a) Locate and repair leaks.
- b) Do not overcrowd parts on the racks.
- c) Orient parts on the rack so they are tilted or tipped to allow proper drainage of planar surfaces, and to reduce the surface area of the part which contacts the bath solution last.
- d) Cover bath tanks when not in use.
- e) Lengthen drip time to reduce drag-out of bath contaminants.
- f) Avoid flooding with water as a clean-up method.
- g) Shut off water flow to rinse tanks when not in use.

5.3.2.3 Retrofits. The following are retrofit alternatives that are low to moderate in cost:

MIL-HDBK-1165

a) Flow restrictors or control systems - restrictors for manual control and controller systems for automation of the flow of freshwater into the rinse tanks.

b) Conductivity controllers - devices used to measure the total dissolved solids in the rinse water and automatically adjust flow control valves.

c) Drip trays (or bars) and drain boards - devices that reduce drag-out during transportation of an item between the plating and rinse tanks by collecting the lost solution and returning it to the plate bath. Figure 14 illustrates such devices.

d) Splash guards - devices which reduce spillage of bath or tank solutions caused by movement of the item in and out of the tank.

e) Wetting agents - cause plating solutions to flow more easily over and attach evenly to the surfaces of the workpiece. This reduces drag-out.

f) Automatic nozzles - for use on continuous flow rinse tanks, these devices allow the operator to shut off the water when not needed, eliminating continuous water flow.

g) Timers - allow the feedwater to the rinse tanks to be automatically shut off when fresh feedwater is not required.

h) Air knives - devices which work by using air streams to blow off excess solution from the plated parts. The excess solution then drops back into the tank, reducing drag-out.

i) Spray rinses - several spray heads are mounted in a tank chamber and either manually or automatically controlled to rinse the workpiece as it is drawn out of the tank. Spray rinsing is not recommended for parts with many sides or small crevices, as the spray will not reach these areas as effectively as a dip rinse.

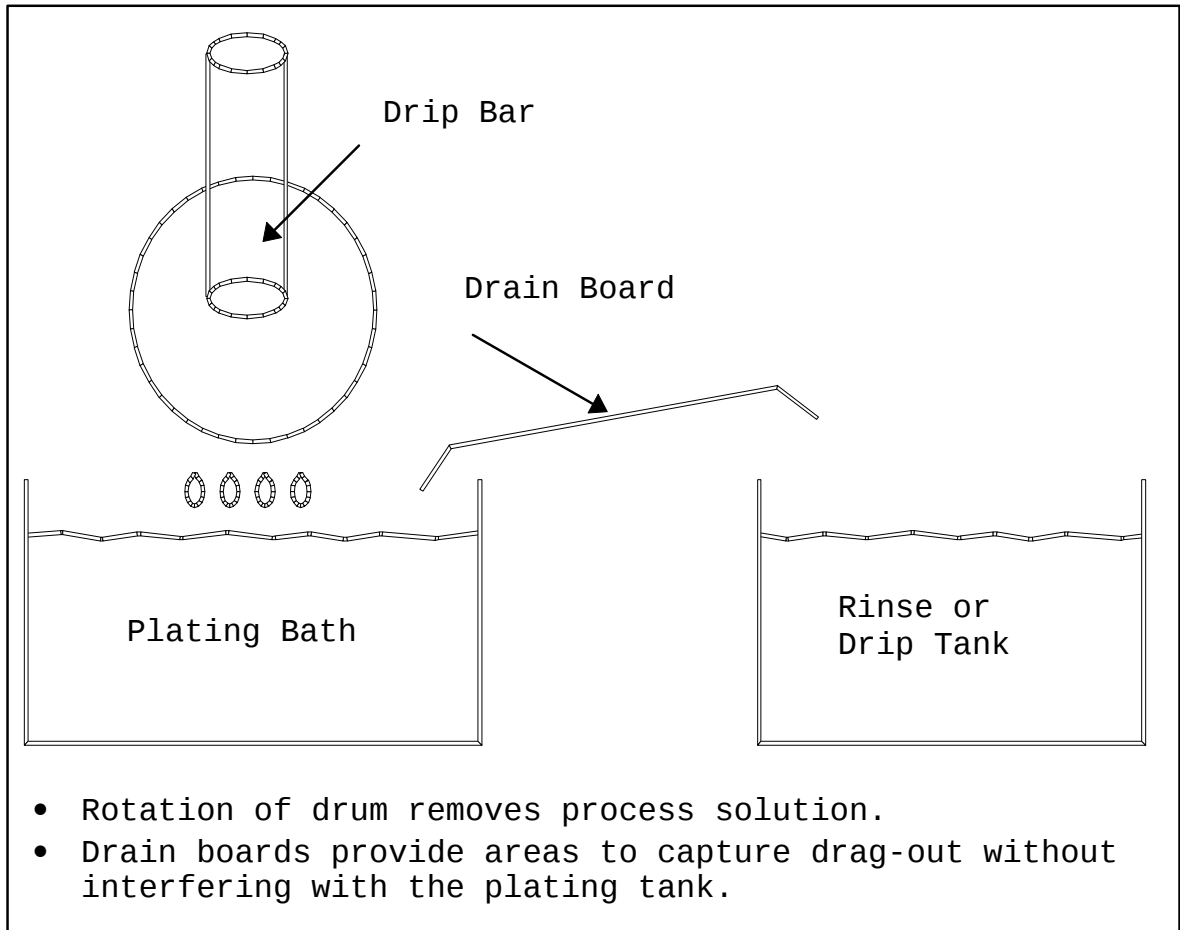

Figure 14  
Drain Board and Drip Bar

j) Static tanks - use more than one rinse tank, making the first one a "static" tank. That is, do not use a continuous overflow tank that is continuously diluted with fresh incoming water. Most of the drag-out from the plated piece can be rinsed into the static tank, leaving the next rinse tanks cleaner longer. The static tank can be refilled as needed, and when concentrated may be recycled or disposed of as waste.

k) Multiple countercurrent rinse systems - employ several tanks that all use the same freshwater feed. The plated parts are successively rinsed in tanks with increasingly clean

water. The water flows in the opposite direction and exits out the first and dirtiest rinse tank.

5.3.2.4 Water Recycling, Reclamation, and Reuse. The procedures and retrofits described above will significantly reduce the amount of water used in rinsing processes. To avoid wastewater discharge altogether (zero discharge), or to at least minimize it, the implementation of a recycling or reclamation system is recommended.

a) Recycling. One type of recycling system that recycles the rinse-water one or more times then discharges it is called "reactive rinsing". It is less expensive than countercurrent rinsing since it does not require extra tanks. Reactive rinsing can be implemented in one of two ways; (1) intraprocess or (2) interprocess.

b) Intraprocess. Intraprocess reactive rinsing can be used for a single plating process that employs several different baths and several rinse tanks to rinse away each solution. Instead of using fresh water for each rinse tank, the discharge from one tank is used as the rinse-water in another tank, if appropriate (meaning the chemicals will not harm the second tank rinse). Thus, the water is reused in the plating process before being discharged.

c) Interprocess. Interprocess reactive rinsing can be used when there are more than one plating processes operating simultaneously. Instead of requiring a separate freshwater feed line for every rinse tank, rinse-waters from rinse tanks in one process are reused in the rinse tanks of another process.

d) Reclamation. Reclamation of used rinse-water or plate bath solutions for use in the same processes requires a more costly and complex approach. There are several separation technologies available that are designed to recover plating metals, acids and other chemicals from the water, but not specifically to conserve the water. If beneficial use of the water itself is the focus, any treatment technique must be capable of producing reclaimed water that is suitable for use in either the rinse tank or plate bath. The major separation technologies include: ion exchange, reverse osmosis, evaporation, and diffusion dialysis or electrodialysis. Filtration should be used as a pretreatment for these methods to first remove undissolved, suspended impurities in the water. A description of each is provided here.



e) Ion exchange. Ion exchange is the same method by which water softeners work. For plating rinse-waters, beds of "ion exchanging" resins retain ions (charged particles) of plating chemicals (metals) which have been dragged into the rinse-water from the plate bath solution, and exchange them (release into the water) with other ions harmless to the rinse-water's application. The retained metals in the resin are then extracted by regeneration. During regeneration, a strong acid or base is used to recover the plating ions by exchanging them for the original resin ions. Depending on the purity of the recovered metals, they can be added back into the plating solution. Ion exchange systems can be set up to regenerate automatically, but still require more operator attention and maintenance than other recovery technologies.

f) Reverse osmosis. Reverse osmosis (RO) uses membranes instead of resins to separate metal salts from rinse-water. Rinse-water is purified by forcing it through the membranes at high pressure, leaving behind the metals. RO membranes are sensitive to oxidizing chemicals and extremely low or high pH's, and are susceptible to fouling in concentrated or hard water solutions.

g) Evaporation. Evaporation simply involves boiling off water from the contaminated rinse-water, condensing the purified water vapors for reuse in the rinse tank, and returning the concentrated leftover metal solution to the plate bath. Evaporation requires thermal energy to operate and thus needs a rinse-water solution of sufficient original plating metal concentration to be cost effective.

h) Diffusion dialysis or electrodialysis. Diffusion dialysis or electrodialysis are more recently developed methods than the technologies listed above, and their effectiveness is still being researched and refined. Dialysis, like reverse osmosis, uses membranes to separate metals from rinse-water. Instead of high pressures, the separation occurs by either placing an electrical charge on the membranes, or by the phenomenon of diffusion. In electrodialysis, charged membranes allow ions of the same charge to pass through. By alternating negative and positively charged membranes, the incoming metals can be separated from the rinse-water. Electrodialysis requires relatively little maintenance and can operate continuously without regeneration. In diffusion dialysis, solutes (metals, acid) move from areas of high concentration to areas of low concentration based on their individual diffusivity, or ability

to travel through the membrane pores. Diffusion dialysis is used to separate clean acid from metal contaminants in acid baths. Diffusion dialysis can operate continuously without regeneration and only requires an electrical source to drive the peristaltic pump. Relatively low flow rates must be used to ensure proper separation making diffusion dialysis a slow recovery process.

i) Filtration. During the plating process, impurities are introduced into the plate bath solution from several sources: the workpiece, the water or chemicals used to make the plating solution, and from drag out of the previous tank. Additionally, in the rinse-water recovery process, along with the desired plating chemicals, some undesirable impurities will also be separated from the rinse-water and returned to the plate bath. This accelerates the level of impurities already present in the bath. Consequently, plate bath solutions must periodically be purified. Filtration combined with electrolytic migration is a technology that can be employed for this and involves electromotively forcing positively charged impurities through a filter and collecting them on a cathode.

5.3.3 Metal Cleaning Facilities. Metal cleaning is an operation employed in a variety of military facilities to prepare metals and metal parts to perform satisfactorily in their intended applications. Examples of military facilities that require metal cleaning include aircraft repair facilities, electroplating facilities, machine shops, paint shops, and ship-fitting facilities. Metal cleaning involves using chemicals to remove dirt, oil, grease, rust, or other contaminants from the metal's surface.

Just as for plating processes, the rinse stage of the metal cleaning process uses the majority of the required water. Rinsing is either conducted by spraying the metal piece or by dipping it into a rinse tank. Generally the rinse tank method consumes significantly more water than spraying. Used rinse-water will contain the chemical(s) used to clean the metal, as dipping it into a rinse tank. Generally the rinse tank method consumes significantly more water than spraying. Used rinse-water will contain the chemical(s) used to clean the metal, as well as the metal contaminants themselves. Chemicals typically used for metal cleaning are solvents, acids, detergents, or alkaline substances. The rinse-water must be of sufficient quality so that the metal parts are not contaminated when sprayed or dipped. Check the process specifications for the tolerable contamination levels for metal cleaning rinse-water.

Contaminated parts will also add the contaminants to the next process tank.

5.3.3.1 Water Recycling, Reclamation, and Reuse. Water conservation options for metal cleaning facilities that use rinse tanks are similar to those for plating facilities. The increased complexity of some metal cleaning rinse solutions may make reclamation efforts more difficult. Reclamation for rinse-water with organic solvent contamination, for example, may require extra treatment steps to extract the solvent. The amount of fresh or reclaimed water needed for the rinse tank may be reduced by reusing water from other sources such as cooling tower discharges and boiler blowdown. Typically, these waters will meet the water quality standards for the process specifications. The volumes of wastewater produced from the spray technique may not be large enough to warrant implementing retrofits, recycling, or reclamation systems.

#### 5.3.4 Painting/Paint Stripping Facilities

5.3.4.1 Conventional and Water-Efficient. Painting of items at military facilities is usually conducted in hangars (aircraft) or in spray paint booths using spray applicators.

a) Paint spray booths. Water is used in spray booth ventilation systems to trap paint particles in the air and flush them away from the operator's breathing space. The water is supplied from a tank and is constantly circulated through the system while the booth is used. Upon replacement with fresh water, the paint-contaminated water likely requires handling as hazardous waste.

b) Paint stripping. Paint stripping of items at military installations is also conducted in hangars or other isolated work areas. Water is used as a rinse to clean off the applied chemical stripper and the loose paint. Depending on the size of the object, the quantity of rinse water can be significant. Items such as aircraft are spray rinsed, smaller items are generally dipped in rinse tanks.

5.3.4.2 Operational and Maintenance Procedures. The simplest conservation option for paint and paint stripping facilities is to alter operational procedures, however, any alterations of your operating procedures must not conflict with the manufacturer's specified parameters. Therefore, before attempting any of the suggestions below, consult your manufacturer's recommended

operating procedures. If these conservation options appear to be applicable to your operation, it is still highly recommended that you periodically check your operations to insure that the equipment is still operating within the manufacturer's recommendations.

a) For paint spray booths:

(1) Reduce the flow of the water to minimum levels that will still catch the airborne paint.

(2) Re-circulate the water more times through the booth before replacing it.

b) For paint stripping facilities:

(1) Squeegee off used stripper and loose paint instead of flushing with water in spray rinsing applications.

(2) Repair leaks in rinse tank connections.

(3) For rinse tanks, many of the water conservation measures used in plating facilities can be applied.

#### 5.3.4.3 Replacements

a) Paint spraying booths. For paint spraying booths, the wet spray booth can be replaced with a dry spray booth. A dry booth uses filters instead of water to extract airborne paint particles from the atmosphere and exhausts any solvent fumes as well. This system eliminates the generation of wastewater that must be treated on-site or disposed of as hazardous waste. The filters are simply exchanged when they become fouled. However, the dry filters, contaminated with paint, are also likely to require handling as hazardous waste. Dry spray booths are relatively low in cost and easy to install. Figure 15 illustrates two types of spray booths must be treated on-site or disposed of as hazardous waste. The filters are simply exchanged when they become fouled. However, the dry filters, contaminated with paint, are also likely to require handling as hazardous waste. Dry spray booths are relatively low in cost and easy to install. Figure 15 illustrates two types of spray booths.

Another option for painting smaller parts is to replace the traditional liquid coatings with powder coatings. Powder coatings are attracted and attached to the workpiece surface in

the form of charged particles, then permanently fused to the surface with high temperature baking. Using powder coatings eliminates the need for exhaust vents and scrubbers for fumes and water sprays for paint collection, and will not produce "paint overspray". No hazardous wastewaters are generated. The cost of installing a powder coating booth system is competitive with installing a liquid coating booth.

b) Paint stripping facilities. For paint stripping facilities, the method of Plastic Media Blasting (PMB) may be an appropriate replacement for chemical strippers. The plastic beads used for blasting are nontoxic and will not harm or etch the workpiece's surface (as sand blasting may). A PMB system also includes a media reclamation device to collect and recycle the plastic beads after use. Dangerous solvent strippers and water used for rinsing are eliminated. No hazardous wastewater is generated. However, the spent bead media must be evaluated for hazardous contamination prior to disposal.

5.3.4.4 Water Recycling, Reclamation, and Reuse. Wastewater from painting or paint stripping facilities may contain a number of hazardous chemicals, making it difficult to reuse in the same process. Water reclamation may, however, be possible for uses such as irrigation. Still, depending on the complexity of the wastewater, extensive treatment might not be cost effective.

Alternately, water from other sources can be used in paint stripping rinse tanks and paint spray booths, as long as the water meets the quality standards in the process specifications. As for metal cleaning facilities, cooling tower discharge and boiler blowdown water may be suitable water sources for painting or paint stripping rinse water.

### 5.3.5 Industrial Laundries

5.3.5.1 Conventional and Water-Efficient. The conventional and new designs of washers, along with their corresponding water consumption, are discussed in paragraph 5.2.6. Front-loading, horizontal-axis washers are a more common sight in commercial and industrial laundry facilities than they are in residential homes and thus these facilities are more advanced in the practice of regularly conserving water. Most large industrial or institutional laundries use what are termed "washer/extractors" that are larger versions of the residential washer and provide more cycle options.

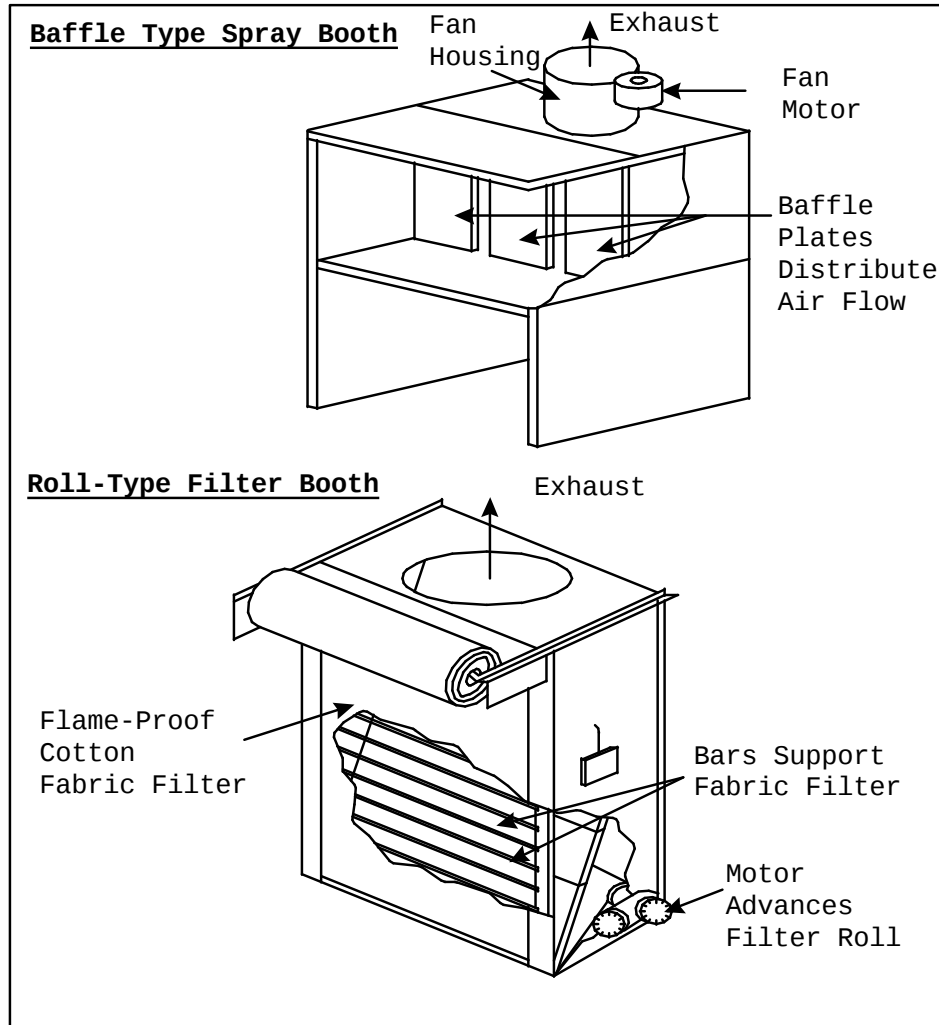

Figure 15  
Two Types of Spray Booths

The military operates laundry facilities to clean linens, uniforms, street clothes, etc. The laundry facility may be a self-serve laundry where base residents and personnel wash their own clothing, or it could be a commercial-type laundry service where base residents drop off laundry to be washed or dry cleaned, or it may be an industrial laundry facility where large volumes of government-owned linens and uniforms are cleaned. Large amounts of water are regularly used in industrial laundries, making them highly suitable for a water conservation program.

5.3.5.2 Operation and Maintenance Procedures. The procedures in 5.2.6.2 can be applied to industrial laundries that use conventional washers.

5.3.5.3 Retrofits. The only retrofits for industrial laundries would be the addition of recycling equipment. Refer to par. 5.3.5.5.

5.3.5.4 Replacements. Besides replacing top-loading, vertical axis washers with horizontal-axis models, there are two major replacement options which may be considered: (1) tunnel washers, or (2) ozone laundering. These are best suited for larger industrial or commercial type laundries, rather than self-service laundries.

a) Tunnel washers. Tunnel washers, also known as continuous batch washers, are heavy-duty, multi-tank systems for use in large industrial laundries. They are capable of handling up to 2000 pounds (4400 kilograms) of laundry per hour, although smaller versions are manufactured also. These washers work by automatically moving batches of laundry from one tank to another and agitating the batches in each tank. The fresh water flows in the opposite direction, much like a plating facility countercurrent rinse system, from the cleanest tank (rinse) to the washing tanks. Continuous batch systems are costly to install (up to several \$100,000), but are capable of saving 60-70 percent of the volume of water used with a washer-extractor, and require less operating and maintenance labor. The system modules use more floor space than extractors, but also handle more laundry.

b) Ozone laundering. Ozone laundering, a fairly new process on the market, could be considered a type of retrofit for commercial laundries' existing washers, but it cleans the laundry by such a unique approach, it is more accurately described as a replacement for the regular way of washing. Ozone laundering is suited for lightly to moderately soiled laundry. It uses no detergent (although a separate tank for detergent washing is sometimes used for final cleaning of heavily soiled items), uses only cold water (absorbs ozone better than warm), and recycles water.

Ozone-generating equipment is attached to the washer as a closed-loop system. It generates the ozone that saturates the cold water supply. The saturated water is then used as the wash water. Ozone is a known powerful disinfectant and oxidizing

agent and thus acts like chlorine, eliminating the need for detergents, thus diminishing the rinse cycles and rinse water discharge. Filters are used to collect dirt and residue from the water before it is resaturated with ozone and returned to the wash cycle.

Although ozone is considered toxic at certain concentrations, equipment manufacturers claim that ozone laundering systems release less ozone to the atmosphere than a copier machine and ozone rapidly degrades in water to molecular oxygen, so there is no danger in handling the wet laundry after the cleaning process has finished. Ozone laundering has been used at several large institutions with good results. It is capable of cleaning the laundry without substantial graying or degradation of the fabric.

5.3.5.5 Water Recycling, Reclamation, and Reuse. Rinse water can usually be recycled to the wash cycle for the next laundry load with no chemical treatment, however, the addition of some fresh water is required to bring the water quality to desired levels for use in the wash load, and some filtering may be needed to catch lint and sediments. Implementing a rinse recycling system is relatively inexpensive and can reduce water usage by 30 percent. Washwater, on the other hand, must be treated before it can be recycled back into the wash process. Figure 16 gives the typical "before and required-after" chemical composition of laundry water. Many washwater recycling treatment systems use inorganic coagulants to draw out water impurities in the form of a sludge. Other systems use step-wise processes, including filtration and carbon adsorption, to remove various wastewater components. Depending on effluent quality, rinse or washwater uses electricity to generate the ozone, causing an increase can be reused as graywater for applications such as irrigation and preliminary rinsing at washracks.



MIL-HDBK-1165

Parameter	Raw Wastewater (mg/L)	Recycle Criteria (mg/L)
Benzene	2/5	0/1
Biochemical Oxygen Demand (BOD)	1,300	30
Chloroform	3.3	0.1
Chromium	0.88	0.1
COD	5,000	100
Copper	1.7	0.1
Lead	4.5	0.1
Nickel	0.29	0.1
Oil & Grease	1,100	10
Perchloroethylene	9.1	0.1
Suspended Solids	1,000	***
Toluene	5.2	0.1
Zinc	3	0.1
Color	---	***
Hardness	---	50 mg/L as CaCO <sub>3</sub>
Odor	---	***
pH	---	7 -8
Total Dissolved Solids	---	2,000

Note:

\*\*\* None Allowable, must be below detection limits.

Figure 16  
Industrial Laundry Water Quality

5.3.5.6 Problems and Pitfalls. Ozone laundering in energy demand for this system. However, this increased energy demand can potentially be offset by the savings in energy not expended on water heating.

For recycling and reuse, the main concern is making sure the water quality is at acceptable levels for the water's future application. Bacterial control is especially important in medical settings.

## 5.4 HVAC Equipment

### 5.4.1 Cooling Towers, Evaporative Coolers, and Once-Through Cooling Systems.

5.4.1.1 Conventional. Cooling towers, evaporative coolers, and once-through cooling systems are some of the largest users of water in facilities with air conditioning or cooling loads. Recall Figure 5, which showed how much water is used by office building cooling and heating systems. Only restrooms consume more water.

a) Once-through cooling. Once-through cooling systems are used for evaporative coolers, ice-makers, hydraulic equipment, and air compressors. They do not recirculate the water, discharging it after using it once. Once-through cooling wastes water.

b) Cooling towers. Cooling towers are the most common type of cooling system for large cooling loads. Cooling towers are used to cool equipment such as air conditioning systems. They work by circulating a stream of water to the equipment and back. The circulating water is cooled by evaporation. A water spray travels against an air flow resulting in a portion of that water evaporating. The water that is left is cooled by heat exchange to the evaporated water droplets. The cooled water travels to the equipment that requires it. There, heat is transferred from the equipment to the water, and the warmed water then returns to the cooling tower to be re-cooled. Figure 17 shows a typical cooling tower in operation.

c) Water losses. Water loss in the recirculating system normally occurs in three ways: (1) evaporation, (2) bleed-off and drift. Make-up water must be added to the cooling tower to replace the lost water. Evaporation is the natural process by which the tower cools the water. It can be estimated that the evaporation rate in a cooling tower equals approximately 2.4 gpm (9 lpm) per 100 tons of (1.2 million BTU's per hour) cooling. Drift results when water droplets are carried away from the by the air flow. Drift usually contains sediment material and is considered part of bleed-off. Only 0.05 to 0.2 percent of the cooling tower's water is lost through drift. Bleed-off is the portion of recirculating water that is purposely released from the tower to remove accumulated impurities. Suspended and dissolved solids accumulate in the circulating water as evaporation removes pure water vapor and increases the

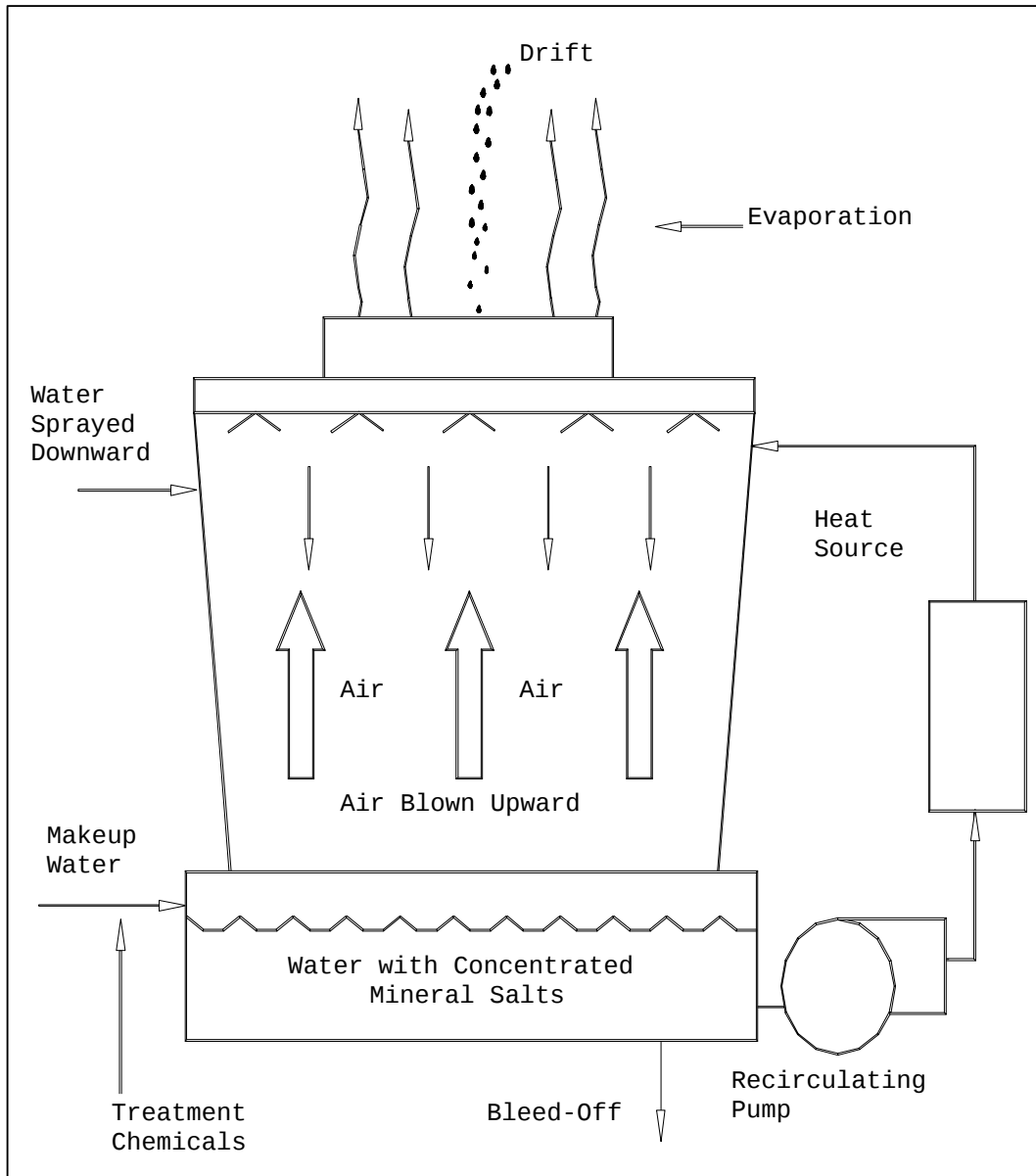

Source : Water Management: A Comprehensive Approach for Facility Managers.

Figure 17  
Typical Cooling Tower Operation.

tower

concentration of impurities in the water left behind. The solids are introduced into the water through the make-up water, from the air used in evaporation, or through corrosion in the re-circulating plumbing. Bleed-off is the only use of water that can effectively be reduced by water conservation.

5.4.1.2 Operation and Maintenance Procedures. The water savings realized by implementing the following suggestions depend on your individual cooling system setup.

a) Locate and repair leaks. Repair any malfunctioning equipment.

b) If a conductivity meter is installed, change the method of releasing bleed-off from a batch method to a continuous method. The batch method involves discharging a large quantity of bleed-off automatically when the water's conductivity reaches a certain preset level. This causes fluctuations in the conductivity of the circulating water and causes the average conductivity to be lower than necessary. Continuous, low volume bleed-off keeps the conductivity steady at the desired level, which conserves water and reduces the need for treatment chemicals.

c) Reduce the amount of bleed-off to the minimum volumes that still produce acceptable circulating water quality.

d) Controlling the amount of bleed-off by the use of chemical additives to the water can be considered a maintenance procedure once established. (Chemical treatment methods are discussed in 5.4.1.5)

5.4.1.3 Retrofits. The following suggestions will aid in reducing the amount of bleed-off to minimum levels consistent with good operating practices:

a) Install flowmeters to monitor the flow of both make-up and bleed-off water to determine any required flow changes.

b) Install a conductivity meter to determine proper frequency of bleed-off. (Refer to par. 5.4.1.2 (2))

c) Install a timer to shut off the cooling tower when cooling is not needed, such as at night when the facility is unoccupied.

d) Sidestream filtration - water is temporarily routed away from the cooling tower through special filters that filter out particles and suspended solids. The cleansed water is then returned to the cooling tower for use, thus reducing bleed-off. The cost of implementing a sidestream filtration system is moderate and requires the addition of energy to run the water pumps. Also, some solids are not as effectively removed as others.

5.4.1.4 Replacements. Replacing a cooling tower system is a large financial investment and is generally not cost-effective unless the existing cooling tower is extremely old, corroded, or malfunctioning and un-repairable. It is the incorporation of the above suggested procedures and retrofits which make the real difference in water use. Once-through cooling systems, on the other hand, should be eliminated when possible, since they waste significant amounts of water by not recirculating it. They can be replaced by air-cooled models.

5.4.1.5 Chemical Additives. The quality of the air stream through the cooling tower and the quality of the make-up water are the major contributors to the quality of the circulating water. Accumulation of contaminants from these sources in the circulating water can lead to scale, corrosion, and biofouling of the cooling tower. Scale is a film of mineral deposits which forms on the surfaces of the circulating plumbing, causing a reduction in water flow and thermal efficiency. Corrosion in the cooling water system results from the water being too acidic, containing a large concentration of metals (causing galvanic corrosion), or being too high in oxygen content. Biofouling is caused by the growth of algae or bacteria in the water to the point that it impedes proper water flow.

a) Chemicals. Chemicals are generally needed in cooling towers to control these contaminants that necessitate bleed-off. By controlling scale, corrosion, biofouling, and other foreign matter; chemicals reduce the amount of bleed-off required and thus conserve water. Organophosphates are typically used as scale and corrosion inhibitors, while a number of biocides, such as chlorine, inhibit fouling. These chemicals are best introduced into the cooling tower system by automatic feeders that respond to the conductivity of the circulating

water. There are numerous vendors available who specialize in determining the proper types and dosages of chemicals for cooling towers. A qualified vendor is one that is able to perform to specifications and maintain a preset level of water chemistry.

b) Sulfuric acid. There is a chemical treatment approach that warrants special mention because of its effectiveness in maintaining cooling tower water quality: sulfuric acid treatment. Sulfuric acid, when added to recirculating tower water, lowers the pH of the water and "digests" metal solids such as calcium bicarbonate (primary cause of scale), thus solubilizing water sediments. Sulfuric acid treatment reduces the amount of bleed-off required by increasing the number of times the water can recirculate. Sulfuric acid is corrosive, however, and care must be taken to ensure that workers do not physically come in contact with it, or that the cooling tower system is not damaged (corrosion) by adding too much (causing a very low pH). The cost of incorporating and operating a sulfuric acid system is relatively low. Discharge of the bleed off may become a problem due to the lowered pH and sewer district restrictions on allowing acidic solutions into the sewer. Due to the environmental concerns associated with sulfuric acid, this method should only be employed if other alternatives are not feasible.

5.4.1.6 Ozone Injection. Ozone generators have proven very effective in biocidal treatment of circulating water in cooling tower systems. Ozone injection has also shown some effectiveness in reducing system corrosion and scaling, although this process may not preclude the need for chemical treatment. By adding ozone treatment you can increase the number of cycles of concentration of your cooling tower water, reducing the water usage accordingly. If ozonation can replace the use of chlorine or other toxic agents, this will also help the installation attain its pollution prevention goals for toxic chemical reduction.

5.4.1.7 Water Recycling, Reclamation, and Reuse. Depending on the quality, the make-up water for cooling towers can come from a variety of sources such as once-through coolers, reject water from RO systems, and high quality municipal wastewater effluent. Incoming make-up water may need to be pretreated by ion exchange, filtration, or lime softening.

a) Reuse. Cooling tower discharge is usable with little or no treatment in many applications that do not require a

high purity water. This depends on the levels of contaminants and/or additive chemicals present. Examples include irrigation, washracks (except final rinse), and paint booths.

b) Recycling. For once-through coolers, if they cannot be eliminated, they could be converted to recirculating systems by connecting them to nearby cooling towers. The existing recycling systems can be improved, by methods mentioned above, and the circulation cycles could be increased. Exact savings will depend on your individual set up, however, an estimation can be made that for a 300-ton cooling tower operating daily at 60 percent capacity, increasing the water circulation cycles (before bleed-off) from 2 to 4 can save nearly 1.5 million gallons (5.7 million liters) per year!

5.4.1.8 Magnets or Electrostatic Field Generators. You may have heard claims from some manufacturers about the effectiveness of magnetic or electrostatic systems to settle out contaminant particles in cooling tower water by altering their charge. These claims are, to date, experimental, controversial, and unproven. More investigation is needed before these treatment systems can be recommended (or disapproved).

#### 5.4.2 Water Heaters

5.4.2.1 Conventional and Water-Efficient. Although water heaters are common in residential houses and offices, they also supply hot water for industrial processes and thus will be discussed here.

Water heater designs vary throughout the world. Whereas the "tankless" water heater (discussed below) is common in Europe, water heaters in the U.S. and Canada are generally the familiar large central tank type. They are either fueled by electricity or natural gas, and have a thermostat, properly called an "aquastat", which activates resistance heating coils inside the tank (electric) or the gas burner (natural gas) when the water temperature drops below the setpoint. The newer water heaters on the market are geared toward being very energy efficient in comparison to older models. Conservation of water in these new tanks occurs as a result of these energy efficient features. For example, new water heaters allow better control of the temperature of the outgoing water that reduces the amount of water consumed. You can improve and maintain the water and energy efficiency of your water heaters by implementing the suggestions given below, as appropriate for your installation. A

schematic of the inner components of a typical natural gas heater is shown in Figure 18 for reference.

5.4.2.2 Operation and Maintenance Procedures. Proper maintenance of existing water heaters is important because of two major problems that affect them: (1) scale or sediment buildup and (2) corrosion. These problems, if left unchecked, can decrease the efficiency of a water heater or even destroy it. Scale and sediment form in hard water environments, corrosion results when soft water is used (to control hard water deposits). The hotter the water, the more accelerated is the scale and corrosion formation, due to the increased formation of corrosive gasses like oxygen and lime deposition. Scale, sediment accumulation, and corrosion decrease the water heater's ability to transfer heat to the water, causing it to consume more energy. Most water heaters employ a "sacrificial" anode that is put in the tank to preferentially corrode when galvanically coupled to the tank. New water heaters also are usually lined with fiberglass or plastic to protect metal parts from corrosion. Even with these internal corrosion inhibitors, the following maintenance procedures should be performed to keep the water heater at peak performance:

- a) Periodically (annually or as needed) drain the water heater and flush out any sediments.
- b) Inspect the anode and replace if completely corroded.

5.4.2.3 Retrofits. There are a number of retrofits that can be performed on a water heater to save heat energy and consequently conserve water:

- a) For new construction, locate the end-use devices closer to the water heater, and choose a heated area for the water heater location.
- b) Install an auto-setback control - it adjusts the aquastat setpoint to the required level right before a time of peak demand, then lowers it during periods of low demand.
- c) Install a premixed water distribution system - a system that is installed between the water heater and the end-use devices. It allows the user to control the water temperature and flow rate precisely by mixing hot and cold water in a central



valve unit. This reduces the amount of water wasted attempting to achieve a desired temperature.

d) Install a 360 degree loop heat trap - an extra circular or square loop on both the inlet and the outlet pipes just above the tank connections. This keeps water driven by convection from traveling from the water heater.

e) An anticonvection valve could also be used to impede convection-forced water flow. It works by using a floating ball and seat. Currently, U.S. manufacturers are providing these valves (inlet and outlet) as standard equipment on heaters.

f) Hot water recovery system - minimizes the loss of leftover hot water in the distribution pipes by drawing it back to the tank. This unit is generally not very large and is mounted on top of the water heater.

5.4.2.4 Replacements. Old, inefficient water heaters should be replaced with today's energy efficient models. Avoid tall thin tanks in favor of shorter, fatter ones that retain heat better by reducing the outward surface area of the water.

Tankless water heaters, common in Europe, do not use a storage tank, but instead heat water as it is drawn for a particular task. This eliminates "standby" heat loss experienced in water heater tanks when there is no demand. Tankless water heaters have limited flow rates and higher installation costs. In a sense, they may actually cause the user to waste more water knowing that the hot water supply will never run out, as it does in a tank system. Tankless water heaters are well suited to applications where continuous hot water is required for discrete and known periods of time, such as in gym or health club locker rooms.

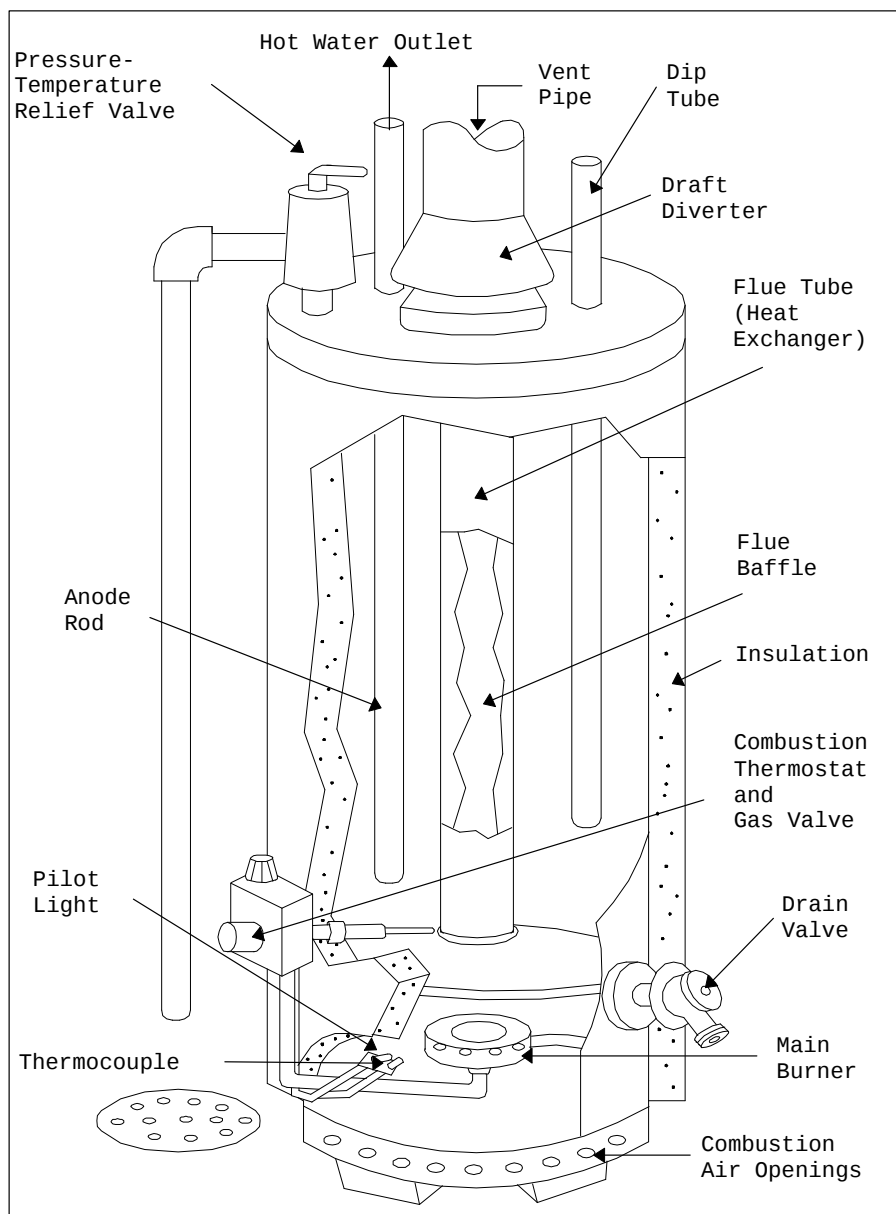

Figure 18  
Typical Natural Gas Water Heater

5.4.3 Boilers and Steam Generators. Boilers and steam generators are used at facilities that need large amounts of steam for heating or generating electricity. Boilers use varying amounts of water to produce steam, depending on their size. They require make-up water to compensate for uncollected condensate, or to replace blow-down water. Blow-down water is water

periodically released from the boiler to remove accumulated solids and sediments. For a more detailed discussion of boilers and steam generators refer to MIL-HDBK-1152, Inspection and Certification of Boilers and Unfired Pressure Vessels.

5.4.3.1 Operation and Maintenance Procedures. The following procedures will help conserve water in your boilers and steam generators:

- a) Inspect the condensate return system, or install one.
- b) Inspect equipment regularly.
- c) Locate and repair leaks in the steam traps and distribution system. Escaping steam wastes water and energy. The steam traps can also be easily replaced, if needed.
- d) Limit the amount of blow-down to the minimum required for properly flushing the system and reaching the desired water quality.

5.4.3.2 Retrofits. Install a condensate return system. This allows the condensate to be returned as make-up water, saving up to 50 - 70 percent of water use, while lowering operational costs due to the higher temperature feed water.

5.4.3.3 Replacements. Unless the existing boiler is very old or beyond repair, it may be much more cost-effective to follow the suggestions above rather than to replace the system. Replacement systems vary according to size and application. Consult a system vendor for advice about your facility.

5.4.3.4 Chemical Use. The addition of corrosion and scale inhibitors will aid the boiler to work more efficiently, extend its life, and reduce water consumption due to a lessened blow-down demand. Condensate return piping should also be chemically treated to reduce the corrosive effects of entrained oxygen and carbon dioxide. However, chemical use should be minimized when possible, in order to help the installation meet its pollution prevention goals.

5.4.3.5 Water Recycling, Reclamation, and Reuse. Depending on the water quality, boiler blow-down may be reused for other water consuming applications such as irrigation.

5.5 Medical Facilities. Other than the common water demands for restrooms, laundries, and cooling & heating, medical facilities have some unique water demands based on their use of specialized equipment. Water conservation options are presented below for this equipment.

5.5.1 X-ray Equipment. After x-rays are taken, special automated processing equipment is used to develop the film. Water is used during the process to rinse the film of its developing chemicals and the silver compounds used to create x-ray images. There are several operational or equipment modifications which can reduce the equipment's water use.

5.5.1.1 Operation and Maintenance Procedures. The following low cost maintenance procedures can help reduce the amount of water used in x-ray machines:

- a) Locate and repair leaks.
- b) Adjust flow rates to the minimum rates recommended by the manufacturer.
- c) Maintain the solenoid control valves in good working order.

5.5.1.2 Retrofits. The following retrofit options can be used to reduce water consumption:

- a) Install flow meters to allow equipment users to control the amount of rinse water used by the processor. A flow rate of 2 gpm is normally sufficient.
- b) Add solenoid valves to shut off rinse and cooling flows when processor is idle.
- c) Install regulators to automatically limit the flow rate of the rinse water.

5.5.1.3 Water Recycling, Reclamation, and Reuse. Reuse the rinse bath effluent for make-up water in the developer solution. Implement a silver recovery unit to collect the valuable metal for reuse in another application.

5.5.2 Sterilizers and Autoclaves. Sterilizers and autoclaves can consume significant amounts of water depending on their age (older units have little or no flow control) and rate of use.

Some facilities may operate one or more sterilizers 24 hours a day. Below are some suggestions to conserve water in these units.

5.5.2.1 Operation and Maintenance Procedures. The following procedures will help maximize your water usage:

a) Adjust flow rates to the minimum rates recommended by the manufacturer.

b) Shut off the unit when it is not being used for an extended period of time.

c) Use a high quality steam supply for improved water efficiency.

5.5.2.2 Retrofits. The following retrofits will help reduce the water usage of your autoclaves and sterilizers:

a) Install an automatic shut off controller to shut down water supply when unit is not in use.

b) Install flow meters and controllers on older units.

5.5.2.3 Replacements. When purchasing a new unit, select one with automatic shut down features and flow controls. Some new sterilizers also have recirculating capabilities.

5.6 Irrigation and Landscaping. Irrigation accounts for approximately 25 - 30 percent of the total water use for urban facilities. Inefficient irrigation and landscaping practices are estimated to waste 40 percent of the water. There are many water conservation options available to reduce or eliminate this waste and cut your facility water costs dramatically. Detailed guidance on landscaping is presented in AWWA's "Water-Efficient Landscape Guidelines." A good, military specific, reference is the "U. S. Air Force Landscape Design Guide".

5.6.1 Operation and Maintenance Procedures. For existing landscaping, the following suggestions will apply:

a) Monitor for leaks and clogged or malfunctioning equipment. Repair as needed.

b) Place sprinklers or sprinkler heads strategically so they water only the desired areas, not sidewalks or roadways.

c) Water in the morning rather than midday or evening. Watering in midday wastes water through high evaporation rates; watering in the evening and leaving the turf or plants wet overnight encourages disease.

d) Adjust the water schedule to seasonal water demand.

e) For most landscaping plants, water deeply and infrequently, rather than lightly and often. This encourages deep roots.

f) Mow turf to the proper height depending on type. Decrease nitrogen fertilizers to improve drought resistance. Aerate turf soil and dethatch the turf to improve water penetration.

g) Control weeds to reduce competition for the water.

h) Water low to the ground rather than high in the air to reduce evaporation losses and more accurately project the water to the desired area.

i) Use mulches to retain moisture in the soil around plants and shrubs.

5.6.2 Retrofits. The following retrofit suggestions will help reduce water usage associated with landscaping and irrigation:

a) If watering is done manually, install an adjustable sprayer on the hose. If appropriate, install one that shuts off automatically when the lever is released.

b) If an automatic irrigation system exists, install updated sensors and controls. Install a timer to automatically activate sprinklers according to a set schedule.

c) Install soil tensiometers to monitor soil moisture. Tensiometers can be wired to the irrigation system's controller to activate the sprinklers when the soil is dry.

5.6.3 Replacements. Replacing an older sprinkler system or a manual one with an updated automated system can save large quantities of water. One replacement option is to replace the sprinkler heads. Sprinkler head design should be consistent with

its desired watering function. For example, low-flow heads should be used in areas with flowers, trees and shrubs, while higher flow heads should be used for turf (where the water must be sprayed over its target area). Some low-flow heads are referred to as "bubblers" because the water is bubbled rather than sprayed.

Another option is drip irrigation. Drip irrigation delivers the water through small diameter tubes connected to pressure-compensating nozzles called emitters. Some emitters can be buried below ground (sub-surface) with their tips located slightly above grade to produce the water drip or trickle. Water flow is reduced from the normal gallons per minute used by traditional sprinkler heads to gallons per hour. A simplified version of drip irrigation is the "soaker" hose. A soaker hose looks like a garden hose but contains many tiny holes that allow water to seep out very slowly to nearby plants. A soaker hose can be buried under the soil surface and is an easy and efficient alternative to manual hose watering. More sophisticated subsurface irrigation systems are also available. Drip irrigation is highly suited to gardens, shrubs, trees, and flower beds.

5.6.4 Xeriscape. The word Xeriscape comes from the Greek word "xeros" meaning "dry". Xeriscape refers to a comprehensive landscaping program that takes into consideration that water is a precious resource that must be conserved. It means implementing landscaping procedures that will produce quality landscapes with limited water use. The benefits of Xeriscape are numerous: reduced water bills and maintenance, increased drought resistance, improved aesthetics, and increased horticultural diversity, just to name a few.

5.6.4.1 Planning and Design. Examine the site and all the factors that will determine the best design and choice of plants for the area:

- a) Drainage requirements.
- b) Sun exposure and areas of shade.
- c) Directional orientation.
- d) Concrete areas.
- e) Weather and precipitation patterns.

f) Water availability and cost.

g) Existing plant or lawn locations and characteristics.

5.6.4.2 Limited Turf Area. Part of Xeriscape involves replacing areas of turf with other plant materials. Turf uses more water than most other plants and thus it should be used sparingly in your landscaped areas. For remaining turf areas, drought resistant species of grass that are native to the area should be selected. Figure 19 presents a number of drought resistant plants.

5.6.4.3 Efficient Irrigation. Many of the procedures and replacements listed previously can be applied (e.g., watering in the mornings versus evenings):

a) Irrigate turf areas separately from other plants.

d) Separate high and low water use plants.

c) Drip irrigation and low volume spray or bubblers for non-turf areas.

d) Catch rainwater and apply to irrigated areas.

e) Subsurface irrigation

5.6.4.4 Soil Improvements. Healthy soil reduces water use and helps plants and turf to thrive:

a) Analyze soil to determine type and needed treatment.

b) Incorporate organic matter.

c) Till the soil to keep it loose and aerated.

d) Incorporate water-retaining material into the soil.

5.6.4.5 Use of Mulches. Organic mulches improve the condition of the soil and allow it to retain more moisture. They also help to control weeds.



MIL - HDBK - 1165

<b>TREES</b>	<b>SHRUBS- cont.</b>
Acacia (many)	Artemisia
Aesculus californica	Caesalpinia gilliesii
Ailanthus altissima	*Calistemon citrinus
Brahea armata	Capparis spinosa
Calocedrus decurrens	*Carnage arborescens
Casuarina	Cassia artemisioides
Ceratonia siliqua	Catha edulis
Eucalyptus (most)	*Cercis occidentalis
Fig (edible)	*Cercocarpus
Geijera parviflora	*Chamaerops humilis
Grevillea	Convolvulus oneorum
Koelreuteria paniculata	Cotoneaster
Lyonothamnus floribundus	Crassula argentea
Maclura pomifera	Crassula falcata
Melia azedarach	*Cupressus glabra
Olea europaea	Cytisus
Parkinsonia aculeata	*Dalea spinosa
Pinus (many)	Dendromecon
Pistacia	*Dodonaea viscosa
Populus fremontii	Echium
Quercus (many)	Elaeagnus
Rhus lancea	Escallonia
Schinus molle	Fallugia paradoxa
Sequoiadendron giganteum	Fremontodendron
Tilia tomentosa	Garrya
Tristania conferta	Genista
Ulmus pumila	*Hakea
Walnut	Hypericum calycinum
Ziziphus jujuba	*Lagerstroemia indica
	Lantana
<b>SHRUBS</b>	Lavandula
Acacia (many)	Lavatera assurgentiflora
*Arbutus unedo	Leucophyllum frutescens
Arctostaphylos	*Lysiloma thornberi
Artemisia	Mahonia
Caesalpinia gilliesii	*Melaleuca (most species)
*Arbutus unedo	Myoporum debile
Arctostaphylos	*Nerium oleander

\* Can become a small tree.

Figure 19  
Drought Tolerant Plants

## MIL-HDBK-1165

<b>SHRUBS-cont.</b>	<b>PERENNIALS, BULBS, ANNUALS-cont.</b>
*Photinia serrulata	Cortaderia selloana
*Pittosporum	Dudleya brittonii
Plumbago auriculata	Echeveria (most)
Portulacaria afra	Eriogonum
*Prunus caroliniana	Euphorbia (most)
*Prunus ilicifolia	Euryops
*Prunus lyonii	Gaillardia
*Punica granatum	Iris, bearded
Pyracantha	Iris (Pacific Coast Natives)
*Rhamnus alaternus	Kniphofia uvaria
*Rhamnus crocea ilicifolia	Leonotis leonurus
Rhus ovata	Leococoryne ixioides
Rosa rugosa	Marrubium vulgare
Rosmarinus officinalis	Mimulus
Salvia clevelandii	Narcissus
Sollya heterophylla	Perovskia atriplicifolia
Spartium junceum	Phlomis fruticosa
*Tamarix	Phormium
Trichostema lanatum	Portulaca grandiflora
*Xylosma congestum	Puya berteroniana
	Romneya coulteri
<b>VINES</b>	Sedum (many)
Bougainvillea	Sisyrinchium bellum
Cissus trifoliata	Tithonia rotundifolia
Tecomaria capensis	Verbena
Wisteria	Yucca (most)
	Zauschneria
<b>PERENNIALS, BULBS, ANNUAL</b>	
Agave	<b>TURFGRASS</b>
Aloe arborescens	Buffalograss
Anacyclus depressus	Bermudagrass
Arctotheca calendula	Zoysiagrass
Baccharis pilularis	Bahiagrass
Baptisia australis	Hard Fescue
Carpobrotus	Sheep Fescue
Cleome spinosa	Red Fescue
Coreopsis	

\* Can become a small tree.

Figure 19 (Continued)  
Drought Tolerant Plants

5.6.4.6 Use of Low-Water-Demand Plants. Hundreds of low-water-use plants are available to conserve water, replace turf, and create a very appealing landscape. (See Figure 19). Higher water-use plants should only be used in areas with sufficient rainfall or in low-lying areas that receive irrigation or rain runoff. Basically, you will want to match the plants chosen to your native environment. Cactus, which grow great in Tucson Arizona, may be very drought tolerant plants, but they will not survive in the Everglades! Plants with like-water demands should be grouped together and watered accordingly. Figure 20 shows a sample drawing of a proper Xeriscape yard with a small turf area and contiguous plant groupings.

5.6.4.7 Appropriate Maintenance. No landscaping program is going to survive without maintenance, and Xeriscape is no exception. Some maintenance tips include:

- a) Weeding and pruning as needed.
- b) Properly adjust equipment.
- c) Mowing turf to proper heights.

5.6.4.8 Water Recycling, Reclamation, and Reuse. As mentioned previously in this handbook, wastewater from other water-consuming applications can be treated and used for irrigation. If a full scale reclamation system is impractical at your installation, then perhaps a graywater system or rainwater catchment would work.

5.6.5 Graywater. Graywater is water from showers, restroom sinks, and washing machines. A graywater system must be implemented with caution. Increasingly, many state and local agencies are placing restrictions on using graywater for irrigation because of possible bacterial health hazards. State or local regulations may require that the graywater treatment system include a combination of sedimentation, filtering, and chemical coagulation processes, along with disinfectants, to remove disease-causing bacteria. Some agencies may also require the graywater to be used only for subsurface irrigation. Graywater should not be allowed to directly contact any edible fruits and vegetables. Graywater typically has a slightly alkaline pH and may be unsuitable for certain acid-loving plants and shrubs. (Also refer to par. 6.2.)

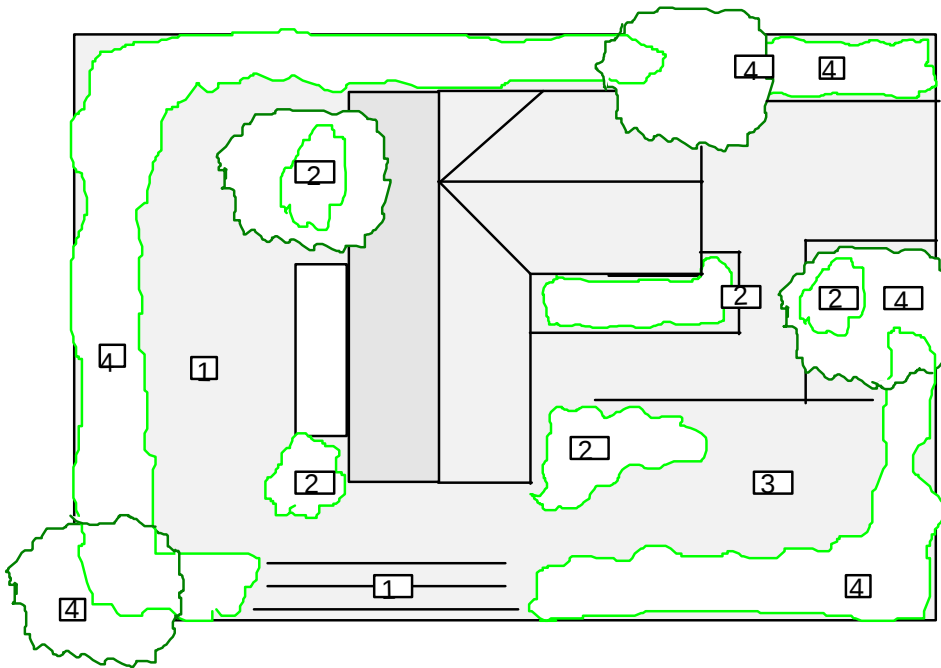

- Zone 1 Turfgrass and vegetable garden with high water requirements.
- Zone 2 Exotic shrubs with moderate water requirements.
- Zone 3 Continuously rooting ground cover with low water requirements.
- Zone 4 Native adaptive trees and shrubs requiring supplemental irrigation during the establishment period.

Figure 20  
Sample Yard Xeriscape

5.6.6 Subsurface Irrigation. Whether you are considering a graywater system or a wastewater reclamation system, subsurface might be the best solution. By watering subsurface, many of the health restrictions concerning human contact can be avoided. With subsurface irrigation coliform and bacteria levels may not be as critical as for surface applied waters, however, total suspended solids does become critical. (Refer to EPA/625/R-92/004 "Guidelines for Water Reuse.") The emitters used with subsurface systems will require more frequent cleaning if the water used contains large amounts of dissolved solids.

5.6.7 Rainwater Catchment. Another option, while not truly recycling, is to set up a rainwater catchment system. Capturing the natural rainfall and using it to irrigate during arid periods will remove the irrigation demand from your existing source and thus conserve that source.

## 5.7 Swimming Pools and Spas

5.7.1 Conventional and Water-Efficient. Though swimming pools and spas may account for only a small percentage of the total water used at a military installation, there are some simple steps that should be implemented to reduce water usage while conserving energy:

a) Cover the pool or spa when not in use. A pool cover can reduce water evaporation by as much as 90-95 percent. It reduces the need for pool filter backwashing by keeping out foreign matter, and it acts as a solar heater when placed over outdoor pools and spas.

b) Lower the water level in the pool or spa. This prevents water loss due to splashing, and also decreases the total volume of water that must be heated and cleaned. If you use pool skimmers for cleaning, ensure that you do not lower the water level so far that the skimmers become useless.

c) Use chemicals properly to maintain water quality and reduce the need for cleaning and refilling.

d) Avoid excess filter backwashing.

For new construction, consider indoor rather than outdoor pools and spas. They require less heating, experience less evaporation, and require less cleaning.

Section 6: WATER CONSERVATION OPTIONS: DISPOSAL

6.1 Sewage Treatment. After your water supply has been distributed and used, it either returns directly to the groundwater, if used for irrigation purposes, or it is collected at a sewage treatment plant. Even at your sewage treatment plant, conservation options are available. Sewage treatment plants do not operate at peak flow 24 hours a day, and in some instances will find periods of operation at less than half of their design flow rate. If the flow into the grit chamber falls below the specified minimum, make-up water must be added in order to keep the plant operating efficiently and effectively. Instead of using potable water for this make-up, a simple effluent return line from the effluent discharge point back to the head end of the plant can be installed.

As with any conservation measure though, an analysis to determine the costs and benefits of such a set up should be performed. If your plant only uses make-up water occasionally, or if the head end is quite a distance from the discharge, then this type of return system may not prove to be economical.

6.2 Water Recycling, Reclamation, and Reuse. In addition to installing the water-conserving devices discussed throughout Section 5, it is also possible for you to conserve water at your base by reusing the water. Common uses of reused water include: irrigation; toilet and urinal flush water; and cooling tower make-up water. EPA/625/R-92/004 Manual, "Guidelines for Water Reuse," contains in-depth discussions on reuse and reclamation systems as well as a state-by-state listing of state regulations and guidelines for these systems.

6.2.1 Types of Wastewater. There are two types of wastewater generated from offices and residential facilities; (1) graywater and (2) blackwater. Graywater is water discharged from bathroom sinks, showers, and washing machines. It generally contains dirt and soap or detergents. Blackwater refers to water used to flush waste from toilets, urinals, dishwashers, and kitchen sinks. It contains food or human waste.

Both graywater and blackwater require some level of treatment before they can be put to beneficial use. Graywater is generally filtered and, if needed, treated biologically or chemically to remove any dangerous, disease-causing microorganisms. It may also require treatment to reduce the levels of cleaners present. Graywater is most commonly used in

irrigation, where potable-grade water is not required and the treatment requirements are less demanding. Figure 21 shows a design for a graywater distribution system for irrigation use. Blackwater obviously requires much more extensive treatment and may involve a number of processes. The cost of implementing such a system on-base can reach hundreds of thousands of dollars. Also, there are regulations regarding the performance of both these systems that must be followed to ensure that public health is not endangered. If you are considering this type of conservation measure, make sure you work closely with your base environmental personnel as well as the local water districts. (Also refer to par. 5.6.5.)

6.2.2 Retrofits. For established facilities with plumbing already in place, implementing an on-site wastewater treatment system will necessitate obtaining access to drain pipes and sewer lines and could involve extensive effort.

When considering if a wastewater treatment and reclamation system may be appropriate for your facility, it will be helpful to answer or consider the following:

- a) How much wastewater does our facility generate?
- b) Which buildings do we want to consider for wastewater recycling?
- c) What will the water be recycled to?
- d) How much of it do we want to recycle?
- e) How extensive a treatment system do we need and want?
- f) Where will the system be built?
- g) What are the implementation costs? Should we lease or buy the system? (Consult with a number of vendors and manufacturers to find out what technologies are available).
- h) What will be the operational and maintenance costs?
- i) Will the ultimate savings from reduced water consumption and discharge costs outweigh the cost of the system?
- j) What is the payback period?

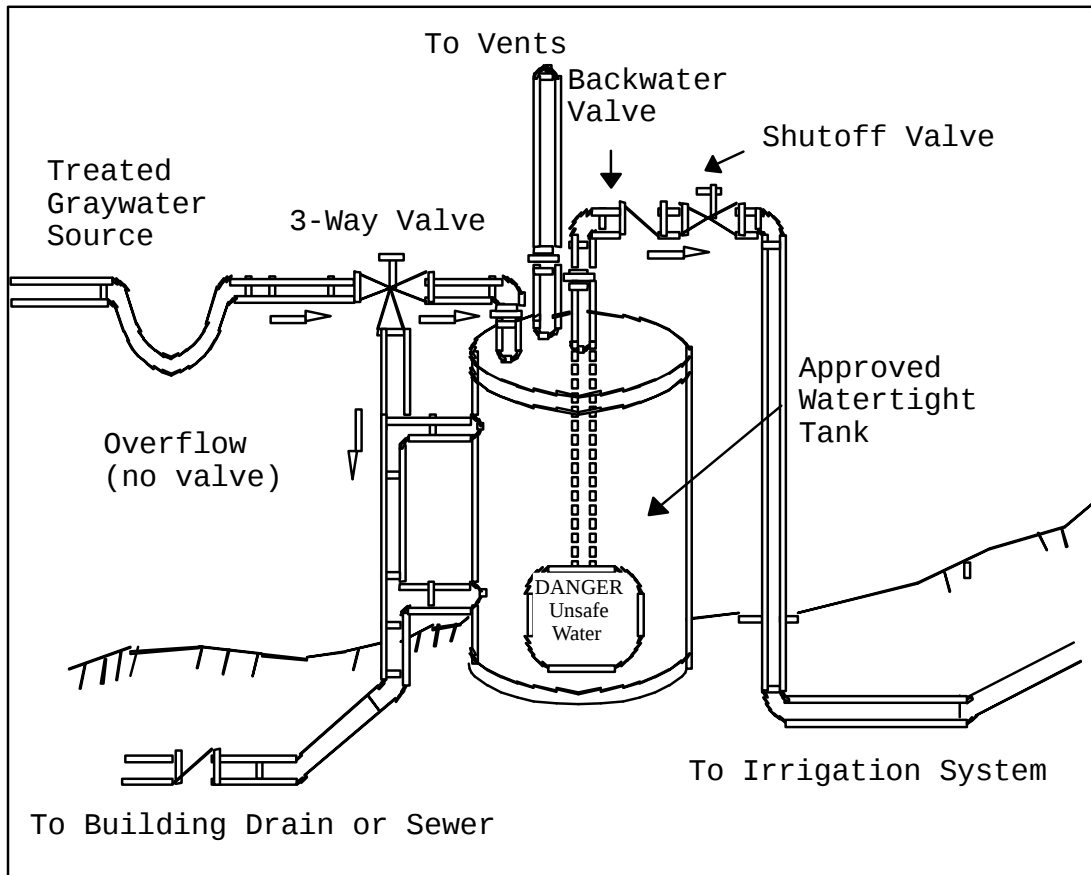

Source: *Proposed Code Change to a Section and/or Sections of the UPC-USPC-USEC* , Submitted to the National Association of Plumbing and Mechanical Officials, Los Angeles, CA, February 1992.

Figure 21  
 Typical Graywater Piping and Distribution System

With careful planning, a wastewater recycling and treatment system can provide significant water savings and reduce the expense of purchasing and discharging facility water.



Section 7: WATER CONSERVATION: SUPPORT

7.1 Software Programs. There are a number of software programs available which address water issues. Several programs deal with water use or specifically, water conservation. The more pertinent of these will be briefly previewed in this section along with vendor data should you wish to obtain further information on the programs themselves.

This listing is not all inclusive, and this handbook is not endorsing or promoting the use of any or all of these products, but merely includes them here for informational purposes to inform you of some of the many sources of support available.

7.1.1 FEDS. Facility Energy Decision Screening (FEDS) is a DOE-FEMP sponsored energy conservation program having a limited water component. It focuses on targeting and prioritizing buildings and end-use retrofit projects for conserving energy. Water conservation is addressed only as it relates to energy savings (e.g., water heaters).

FEDS allows detailed energy information to be inputted and in return, provides detailed project-by-project information about retrofit technology selection and economic information. It helps the user to estimate post-retrofit energy consumption, initial installed cost of the retrofits, recurring costs of the retrofits, value of the change in energy consumption and operation and maintenance requirements, and net present value of the retrofits.

7.1.1.1 Vendor Information

U.S. Department of Energy  
Office of Federal Energy Management Programs  
Code EE-44  
Washington, DC 20585

Ph: (800) 566-2877  
(FEMP Helpline)

7.1.2 IWRAPS. Installation Water Resources Analysis and Planning System (IWRAPS) is a water forecasting tool for military facilities. A version of the program has been developed for each service. These versions contain water-use coefficients developed from actual data obtained from nationwide surveys of military

bases. This tool is based on building square footage, base population, and weather data. Additionally, this program may be used to "back-cast" water data for use in water rights negotiations and can be used to explore mobilization impacts on your water system. In producing future water requirements, IWRAPS incorporates planned construction or demolition projects.

7.1.2.1 Vendor Information

Planning and Management Consultants, Ltd.  
6352 South U.S. Highway 51  
PO Box 1316  
Carbondale, IL 62903

(618) 549-2832

7.1.3 WATERGY. The WATERGY program is a spreadsheet model that uses water-energy relationship assumptions to analyze the potential of water savings and the associated energy savings. The program allows input of utility and facility data, and then calculates annual direct water, direct energy, and indirect energy savings, as well as total cost and payback periods for a number of conservation methods.

7.1.3.1 Vendor Information

Federal Energy Management Program Help Desk  
(800) DOE-EREC (362-3732)

7.1.4 WAVE-Saver. The WAVE-Saver software is part of the Water Alliance for Voluntary Efficiency (WAVE) program, a voluntary, non-regulatory partnership program between the EPA and hotels and motels. WAVE's mission is to encourage businesses and institutions to reduce water use while increasing efficiency and profitability. The WAVE-Saver software is a survey and tracking tool, that can help reduce water and sewer expenses up to 30 percent for hotels and motels, or in military terms, barracks, officer and enlisted quarters, and lodges.

7.1.4.1 Vendor Information

WAVE Program Director  
U.S. EPA  
401 M St. SW - Mail Stop 4204  
Washington, DC 20460

Ph: (202) 260-7288  
Fax: (202) 260-1827

7.1.5 Water Management Tool for Federal Office Buildings. A water management tool is currently being developed for use in Federal office buildings. This tool will build upon the capabilities of the WAVE-Saver software described above with its use tailored to Federal facilities and will provide the tools needed to respond to Federal mandates for water conservation.

The software will be an artificial intelligence system designed to help manage water use with an integrated multimedia database and tutorial package.

7.1.5.1 Vendor Information. Once the software is completed, it will be available through the Federal Energy Management Program's Help Desk (800) DOE-EREC (363-3732).

7.1.6 Leak Audit. The Leak Audit software is a menu-driven program designed to assist municipal water utilities to conduct audits and reduce leak losses in water distribution systems. The program uses the collected data to quantify water and revenue losses, thereby helping water utilities determine appropriate measures for reducing water and revenue losses. Although written for water utilities, the information and electronic worksheets may be useful to facility managers on military installations as well.

The Leak Audit program is designed to be used with the Water Audit and Leak Detection Guidebook published by the California Department of Water Resources and AWWA.

7.1.6.1 Vendor Information

Department of Water Resources  
Division of Local Assistance  
1020 Ninth Street  
PO Box 942836  
Sacramento, CA 94236-0001

Ph: (916) 327-1649  
Fax: (916) 327-1815

7.1.7 Residential Water Conservation Techniques. This program is a graphics-based tutorial of residential water conservation techniques. It provides potential water and revenue savings resulting from installation of efficient water-using devices.

The program is provided by the Center for Technology Transfer and Pollution Prevention (CTTPP) at Purdue University Agricultural and Biological Engineering Department. Part of the CTTPP's mission is to evaluate and develop new computer-based technology transfer opportunities. The CTTPP is supported by the U.S. EPA and the USDA.

7.1.7.1 Vendor Information

Farm Building Plan Service  
1146 AGEN Building  
Purdue University  
West Lafayette, IN 47907-1146

Ph: (317) 494-1173  
Fax: (317) 496-1115

7.1.8 WELP. The Water-Efficient Landscaping Planner program (WELP), provided by CTTPP, covers the basics of water conserving landscaping. It describes the advantages and principles of utilizing water-efficient landscaping and provides guidelines on selecting plants. It is intended for residential use, but the information can be applied to any landscaped area.

7.1.8.1 Vendor Information. (Refer to par. 7.1.7.1.)

7.1.9 AWWA Software. AWWA offers a variety of utility-oriented specialized software. These may be of limited use to you, depending on your facility situation.

7.1.9.1 WATERNET. A CD-ROM database containing some 30,000 references of literature from around the world on a wide variety of water topics. Cited journals include: Journal of American Water Works, Aqua Journal of Water Supply and Technology, and the Journal of Water Resources Planning and Management.

7.1.9.2 Well System Manager Software. This program automates record keeping and performance evaluations for water wells. It may be useful to facilities using on-site wells as a water source.

7.1.9.3 WALTER. WALTER is a system designed to aid operators of water treatment plants. This tool assists water operators of both large and small treatment plants to diagnose common water treatment problems associated with chemical addition, flocculation, sedimentation, filtration, and chlorination. It may be useful for facilities that operate on-site recycling or reclamation systems.

7.1.9.4 Meter Inventory Software. This software is a water meter record keeping tool that assists system managers to manage the inventory and maintenance records of all meters in the system; and is for installations with individual, on-site water meters.

7.1.9.5 Vendor Information

American Water Works Association  
6666 W. Quincy Ave.  
Denver, CO 80235

Ph: (800) 926-7337

7.2 Internet Sites. Figure 22 contains a listing of water related internet sites. This listing, while not all inclusive, does cover many of the major players in water conservation. Through links at each of these sites to other water related sources, governmental agencies, and universities, it should provide you with more assistance, reports, studies, and bulletin boards, than you will probably need to successfully manage your water resources.

Internet Site	Internet Address
AWWA FEMP WaterWiser Water Net Water Online U.S. Geological Survey Water Web Soil and Water Conservation Society	www.awwa.org www.eren.doe.gov/femp www.waterwiser.org www.waternet.com www.wateronline.com h2o.usgs.gov www.waterweb.com www.swcs.org
Army Center for Public Works	www.usacpw.belvoir.army.mil
Naval Facilities Engineering Service Center	www.nfesc.navy.mil
Air Force Civil Engineer Support Agency	www.afcesa.af.mil/AFCESA

Figure 22  
Water Related Sites on the Internet

7.3 Additional Reading. In addition to the references incorporated as part of this handbook (refer to References), the following publications offer more detailed information into many of the topics discussed in this handbook. These publications are not a part of this handbook, but provide additional information that may be helpful to some readers. These are listed for readers who desire more in-depth discussion of particular topics.

7.3.1 American Water Works Association. Publications from AWWA, Denver CO.:

- a) Augmenting Potable Water Supplies With Reclaimed Water, 1997.
- b) Babcock, Thomas M. et. al. Ed. The Water Conservation Manager's Guide to Residential Retrofit, 1993.
- c) Back to Basics Guide to Water Conservation, 1991.

- d) Leaks in Water Distribution Systems, 1987.
- e) Obmascik, Mark A. A Consumer's guide to Water Conservation, 1993.
- f) Proceedings of Conserv 93 - The New Water Agenda (Sessions W3-1 through 4A-6), 1993.
- g) Proceedings of Conserv 93 - The New Water Agenda (Sessions 4B-1 through 7C-3), 1993.
- h) Proceedings of Conserv 96 - Responsible Water Stewardship, 1996.
- i) Wallace, L. P. Water and Revenue Losses: Unaccounted-For Water, 1987.

7.3.2 Rocky Mountain Institute. Publications from RMI, Snowmass, CO.:

- a) Chaplin, Scott W. Water-Efficient Landscaping, 1994.
- b) Jones, Andrew P. High-Efficiency Showerheads and Faucets, 1993.
- c) Laird, Colin. Water-Efficient Technologies - A Catalog for the Residential/Light Commercial Sector, 1991.
- d) Menke, K. and J. Woodall. Water Productivity and Development Strategies for More Efficient Use, 1990.
- e) Water Efficiency - A Resource for Utility Managers, Community Planners, and Other Decision Makers, 1991.
- f) Graywater Systems, Composting Toilets, and Rainwater Collection Systems: A Resource List, 1993.
- g) Waterless Toilets: Guides, Manufacturers, and Plans, 1993.
- h) Woodwell, J. C., et. al. Water Efficiency for Your Home: Products and Advice Which Save Water, Energy, and Money, 3rd Ed., 1995.

7.3.3 Environmental Services Department. Publications from the Environmental Services Department - City of San Jose, CA.

a) Water Conservation Guide for Office Buildings and Commercial Establishments, 1992.

b) Water Conservation Guide for Schools, 1992.

c) Water Conservation Guide for New Construction, 1992.

d) Water Conservation Guide for Hotels and Motels, 1992.

e) Water Conservation Guide for Printed Circuit Board Manufacturers and Metal Finishers, 1992.

f) Water Conservation Guide for Computer and Electronic Manufacturers, 1992.

g) Water Conservation Guide for Restaurants, 1992.

h) Water Conservation Guide for Hospitals and Health Care Facilities, 1992.

7.3.4 Other Publications.

a) Bancroft, Brady, et. al. State of the Art Technology Guide - Water Heating, E Source, Inc. Boulder, CO. 1993.

b) Black and Veatch. A Guide to Water Conservation for Cooling Towers, Department of Water and Power - City of Los Angeles, CA. 1991.

c) California Department of Water Resources. Water Efficiency Guide for Business Managers and Facility Engineers, California Department of Water Resources, Sacramento, CA. 1994.

d) Camacho, Norma, et. al. Water Conservation Technology Guide, NEESA-1-040, Naval Energy and Engineering Support Activity, Port Hueneme, CA. 1985.

e) Carr, C., and C. Pike. Water Audit and Leak Detection Guidebook No. 5, California Department of Water Resources, Sacramento, CA. 1986.



- f) Chan, D.B. and A. Law. Water Conservation Technology Document, TM-71-85-09, Naval Civil Engineering Laboratory, Port Hueneme, CA. 1985.
- g) Chaplin, S., and J. Dyer. The Beauty of Water-Efficient Landscaping, Energy Ideas, Vol. 1, No. 3, Sept. 1992.
- h) Engdahl, Don, and Frank Farmer. How To Do a Residential Retrofit Program, Water Conservation Guidebook No. 1, California Department of Water Resources, Sacramento, CA. 1981.
- i) Environmental Protection Agency. Guidance Document for Effluent Discharges from the Auto and Other Laundries Point Source category, 1982.
- j) General Services Administration. Water Management - A Comprehensive Approach for Facility Managers, General Services Administration, Washington, DC. 1994.
- k) Pacific Northwest Laboratory. Water Resource Management (Course Manual), Pacific Northwest Laboratory/Federal Energy Management Program - Department of Defense, 1995.
- l) Prillwitz, Marsha. Landscape Water Conservation Guidebook, California Department of Water Resources, Sacramento, CA. 1988.
- m) Scholze, R. J. et. al. Water Conservation Methods for U.S. Army Installations: Volume I, Residential Usage Management, Construction Engineering Research Laboratory (CERL) - Army Corps of Engineers, Champaign, IL. 1983.
- n) Scholze, R. J. et. al. Water Conservation Methods for U.S. Army Installations: Volume II, Irrigation Management, CERL - Army Corps of Engineers, Champaign, IL. 1983.
- o) Waterless Co. No Flush Urinals - State of the Art in Water Conservation (Product Brochure), Waterless Co. San Diego, CA. 1994.

APPENDIX A  
EXECUTIVE ORDER 12902 SUMMARY

I. REQUIREMENTS UNDER EXECUTIVE ORDER 12902

A. BACKGROUND

1. On March 8, 1994, President Clinton signed Executive Order 12902, "Energy Efficiency and Water Conservation at Federal Facilities." The following summary of its requirements is taken from the GSA publication, "Water Management, A Comprehensive Approach for Facility Managers":

2. The order requires Federal facilities to assess and, where cost-effective, implement measures to improve the efficiency of Federal energy and water use. A cost-effective measure is defined as one having a payback period of 10 years or less, as determined by using the methods and procedures developed and pursuant to 42 U.S.C. 8254 and 10 CFR 436.

3. Each Federal agency is to develop and implement a program to reduce energy consumption in Federal buildings 30 percent by the end of the year 2005--relative to 1985 energy use--to the extent that measures are cost-effective. (For Federal industrial facilities, the goal is a 20 percent reduction, relative to a 1990 benchmark.) While no specific targets are set for reductions in water use, water-conservation measures are required where they are cost-effective.

4. The Department of Energy (DOE) will take the lead in implementing the Order through the Federal Energy Management Program. DOE must also make available by September 3, 1994, a national list of companies providing water services and a list of qualified energy service companies. The Interagency Energy Policy Committee (the 656 Committee) and the Interagency Energy Management Task Force (the Task Force) will coordinate the implementation of efficiency measures among federal agencies.

5. Each Federal agency responsible for managing Federal facilities must perform a prioritization survey by September 1995 on each facility that agency manages. A prioritization survey is a rapid facility assessment "to identify those facilities with the highest priority projects based on the degree of cost effectiveness." The prioritization surveys will also establish priorities for conducting comprehensive facility audits. In other words, although all facilities must receive

APPENDIX A

both a prioritization survey and a comprehensive facility audit, the prioritization surveys determine which facilities receive comprehensive facility audits first. A comprehensive facility audit must include the following information:

a. The type, size, energy use, and performance of the major energy-using systems and their interaction with the building envelope, climate and weather influences, usage patterns, and related environmental concerns.

b. Appropriate energy and water conservation maintenance and operating procedures.

c. Recommendations for the acquisition and installation of energy conservation measures, including solar and other renewable energy and water conservation measures.

d. A strategy to implement the recommendations.

6. By March 8, 1995, agencies must identify, based on the prioritization surveys, their most high-priority facilities and complete at least 10 percent of the comprehensive facility audits on those facilities. Within 180 days after completion of the comprehensive facility audit, a facility must start to implement recommendations for energy efficiency, water conservation, and renewable water technologies. Thereafter, an agency must perform comprehensive facility audits on at least 10 percent of its facilities each year.

7. Each Federal agency must report annually to DOE and the Office of Management and Budget on progress toward meeting the goals of the order. Agencies are encouraged to use innovative funding mechanisms, including demand side management programs, shared energy savings performance contracts, and energy savings performance contracts. By September 3, 1994, GSA must prepare and make available to Federal facility managers a list of all utilities that offer "no-cost" energy efficiency and water conservation audits and demand side management services and incentives.

APPENDIX B  
WATER AUDIT SURVEY FORMS

I. GENERAL

A. FORMS

1. The forms comprising this appendix can be used to assist you in performing water audits. They were developed by the Naval Facilities Engineering Service Center. A complete listing of the forms follows:

<u>Figure</u>	<u>Page</u>
B-1 Points of Contact (Water Audit).....	91
B-2 Source Water (Water Audit).....	92
B-3 Cooling Towers (Water Audit).....	93
B-4 Boiler/Cogeneration (Water Audit).....	94
B-5 Landscape Irrigation (Water Audit).....	95
B-6 Base Population (Water Audit).....	96
B-7 Waste Water and Reclamation (Water Audit).....	97
B-8 Building Survey (Water Audit).....	98
B-9 Industrial Processes (Water Audit).....	99
B-10 Wash Facilities (Water Audit).....	100

MIL-HDBK-1165

APPENDIX B (Continued)

Base Name			
KEY PERSONNEL	Name	Phone	Fax
Public Works Officer/Base Civil Engineer			
Staff Civil Engineer			
Engineering Manager			
Utility Manager			
Water Distribution Foreman			
Water Treatment Foreman			
Waste Water Treatment Plant Foreman			
Golf Course Manager			
Energy (Water) Manager			
Irrigation Supervisor			
TOP TEN WATER USERS			
1			
2			
3			
4			
5			
6			
7			
8			
9			
10			
MAJOR TENANT COMMANDS			
REMARKS			

Figure B-1  
Points Of Contact (Water Audit)

MIL-HDBK-1165

APPENDIX B (Continued)

SOURCE OF WATER	Pumped/ Purchased	Aquifer Name or Supplier	Prior Year Consumption	Metered?
Source 1				
Source 2				
Source 3				
Source 4				
<b>COST OF WATER</b>	Source 1	Source 2	Source 3	Source 4
Pump				
Electricity				
Aquifer Extraction Fees				
Well Certifications/Permit s				
Labor				
Purchase				
Processing				
Labor				
Electricity				
Softener Salts				
Water Sampling				
Distribution				
Maintenance				
E/S Repairs (Breaks)				
Water Meter Reading				
Chlorination				
Flushing				
Back Flow Testing				
Heating				
ACTUAL COST		MARGINAL COST		
REMARKS				

Figure B-2  
Source Water (Water Audit)

MIL-HDBK-1165

APPENDIX B (Continued)

Unit Number_____	Location_____
Serving_____	
Capacity/Tons_____	Concentration Ratio_____
Manufacturer_____	Model_____
Process/HVAC_____	Hours/day_____
MAKEUP	
Water Source_____	Meter Number_____
Backflow protected_____	Pretreatment_____
Consumption Daily_____	Annual_____
Makeup Conductivity_____	Compressed Air Available_____
CHEMICAL TREATMENT	
Biofouling Chemicals_____	Annual Cost_____
Descale Chemicals_____	Annual Cost_____
Method of Control_____	
FILTRATION	
Type: Side Stream/Full Flow_____	
BLOWDOWN	
Control Type: Conductive/Timer/Fixed Rate_____	
Conductivity_____	PH Level_____
Bleed off: Daily_____	Evaporation_____
LABOR	
Maintenance Man hours_____	Cleaning Man hours_____

Sketch Layout on Back of Form

Figure B-3  
Cooling Towers (Water Audit)

APPENDIX B (Continued)

Unit Number_____	Location _____	
Serving_____	Type: Steam/Hot Water_____	
Fuel Type_____	Capacity_____	
FEED WATER		
Water Source _____	Meter Number_____	
Consumption Daily_____	Annual _____	
Type of treatment_____		
BLOWDOWN		
Amount_____	Method of control_____	
CONDENSATE		
Metered_____	Amount Daily_____	Annual_____
COGENERATION		
Type: Turbine Diesel Boiler_____		
Manufacturer and Model_____	kw_____	
REMARKS		
_____		
_____		
_____		
_____		
_____		

Figure B-4  
Boiler/Cogeneration (Water Audit)



APPENDIX B (Continued)

Area Description \_\_\_\_\_

Meter Number \_\_\_\_\_ Backflow Protected \_\_\_\_\_

Manual/Automatic \_\_\_\_\_ Operator \_\_\_\_\_

Sensors Rain/Moisture \_\_\_\_\_ Square Footage \_\_\_\_\_

Water Source \_\_\_\_\_ Annual Labor M/H \_\_\_\_\_

	Number/Type of Fixtures	Summer Schedule Days/week Min/day		Winter Schedule Days/week Min/day	
Station 1					
Station 2					
Station 3					
Station 4					
Station 5					
Station 6					
Station 7					
Station 8					
Station 9					
Station 10					

Application Rate:

	Winter	Summer	Total
Inches			
K/gallon			
Cubic Feet			
Acre Feet			

REMARKS \_\_\_\_\_

Figure B-5  
Landscape Irrigation (Water Audit)

MIL-HDBK-1165

APPENDIX B (Continued)

FULL TIME EMPLOYEES  
(For calculating water use)

	Average #
DoD Civilians	
Military	
MWR/Exchange	
Other	
<b>TOTAL</b>	

ON BASE QUARTERS

	No. of Units	Average Occupancy	percent Occupancy
BEQ/VEQ			
BOQ/VOQ			
Enlisted Housing			
Officer Housing			
<b>Total</b>			

REMARKS

---



---



---

Figure B-6  
Base Population (Water Audit)

APPENDIX B (Continued)

How much effluent is processed? \_\_\_\_\_ Kgallons per:  
Day    Week    Month

Capacity of the treatment plant? \_\_\_\_\_ Kgallons per:  
Day    Week    Month

Where is the secondary effluent discharged to?  
\_\_\_\_\_

Is any water being processed for reclaimed purposes?  
\_\_\_\_\_

    If Yes, How Much and for what purpose:  
\_\_\_\_\_

Is there any open or pending discharge issues for quantity or  
quality?  
\_\_\_\_\_

Has a Master Plan been developed for the sewage treatment  
plant? \_\_\_\_\_

COSTS (The following section is to determine the actual and  
marginal cost of processing waste water.)

Electricity cost \_\_\_\_\_ per: Month    Year

Potable water: \_\_\_\_\_ Kgal per: Month    Year

Chemicals \_\_\_\_\_ per: Month    Year

Laboratory/Testing \_\_\_\_\_ per: Month    Year

Permit Fees:

Discharge Fees:

Labor, Operation and Maintenance:

Solid waste disposal:

Reclamation Opportunities/Remarks  
\_\_\_\_\_

Figure B-7  
Waste Water & Reclamation -(Water Audit)

APPENDIX B (Continued)

Building Number \_\_\_\_\_ Type \_\_\_\_\_  
 Location \_\_\_\_\_ Occupants (Total) \_\_\_\_\_  
 Men \_\_\_\_\_ Women \_\_\_\_\_ Children \_\_\_\_\_  
 Meter Number \_\_\_\_\_ Annual Water Usage \_\_\_\_\_  
 Garbage Disposal \_\_\_\_\_ Kitchen Sink \_\_\_\_\_  
 Dishwasher \_\_\_\_\_ Deep Sink (Qty.) \_\_\_\_\_  
 Wash Machines \_\_\_\_\_ Toilets (Qty.) \_\_\_\_\_  
 Urinals \_\_\_\_\_ Showers \_\_\_\_\_

Sample Fixture Flow Rates

Location	Fixture	Time	Rate	Location	Fixture	Time	Rate

Wastewater \_\_\_\_\_ Recycled water use \_\_\_\_\_  
 (Sewer/IWTP/Septic/Other) (Toilets/Urinals/Cooling  
 Tower/Irrigation)

Remarks

---

—

---

—

Figure B-8  
Building Survey (Water Audit)

MIL-HDBK-1165

APPENDIX B (Continued)

Process	Building	Usage	Source	Effluent
Paint Stripping				
Spray Painting				
Metal Cleaning				
Metal Plating				
Autoclave				
Fume/Air Scrubbers				
Dynamotor				
Turbine Test Stands				
Water Pretreatment				
Reverse Osmosis				
Source Treatment Units				

Notes \_\_\_\_\_

Figure B-9  
Industrial Processes (Water Audit)

APPENDIX B (Continued)

Wash Rack	Building	Usage	Source	Effluent	Separator
Government Vehicles					
MWR Car Wash					
Aircraft Wash					
Notes					
<hr/>					
<hr/>					
<hr/>					
<hr/>					
<hr/>					
<hr/>					

Figure B-10  
Wash Facilities (Water Audit)

APPENDIX C  
ARMY SPECIFIC PROGRAM, RESOURCES, AND POC'S

I. THE ARMY PROGRAM

A. Water conservation is part of the Army Facilities Energy Management Program. HQDA philosophy is to allow each MACOM the flexibility to create and maintain its own energy and water program. Each MACOM is to achieve the goals set forth in EAct and EO 12902. HQDA, USALIA, and USACPW will support and assist MACOMs in their endeavors to the fullest extent possible. Further information on the Army Energy Program can be found in the DoD Energy Manager's Handbook.

B. Water conservation projects undertaken to comply with the requirements of EAct or EO 12902 are treated like energy projects, and compete for funding from the same sources. Many water conservation projects are low-cost/no-cost measures (showerhead replacement, irrigation scheduling, etc.) which are funded at the installation level. Larger projects, or small ones that can be bundled together (replacement of plumbing fixtures in a group of buildings, installation of a computer-controlled irrigation system, etc.), can compete for Federal Energy Management Program (FEMP) or Energy Conservation Investment Program (ECIP) funding through the Army Facilities Energy Program. Contact your MACOM Energy Manager, or the appropriate program POC listed at the end of this Appendix for details on submitting projects for funding.

II. ADDITIONAL ASSISTANCE

A. POINTS OF CONTACT

1. Office of the Assistant Chief of Staff for Installation Management (OACSIM). The OACSIM is the proponent of the facilities energy program and is responsible for policy, programming, and guidance of the program. The Energy Team at the Facilities Policy Division of the OACSIM provides installation policy guidance, develops resource requirements, prioritizes ECIP/FEMP projects, and chairs Tri-Service and DA steering committees. OACSIM POC's:

APPENDIX C (Continued)

(ECIP)

a. Energy Conservation Investment Program

Mr. Hank Gignilliat  
(703) 428-7003 DSN 328  
FAX: 428-6197  
e-mail: gignilli@pentagon-acsim3.army.mil

b. Federal Energy Management Program (FEMP)

Mr. Qaiser Toor  
(703) 428-8203 DSN 328  
FAX: 428-6197  
e-mail: toor@pentagon-acsim3.army.mil

2. US Army Center for Public Works. The USACPW provides guidance and technical assistance for water conservation and for centrally managed programs such as Energy Savings Performance Contracts and Demand Side Management. USACPW manages a training course for energy managers; this course meets the requirements of Public Law 102-486 for trained energy managers at Federal facilities. USACPW POC's:

a. Water Conservation

Ms. Jane Anderson  
(703) 806-5214 DSN 656  
FAX:(703) 806-5216  
e-mail: jane.l.anderson@cpw01.usace.army.mil

b. Energy Savings Performance Contracting

Mr. Roger Cundiff  
(703) 806-6102 DSN 656  
FAX: (703) 806-5220  
e-mail: roger.e.cundiff@cpw01.usace.army.mil



APPENDIX D  
NAVY SPECIFIC PROGRAM, RESOURCES, AND POC'S

I. THE NAVY FUNDING PROCESS

A. TYPES OF FUNDING

1. Once you have performed the facility audit and determined which water conservation projects to implement, you will need to arrange for funding. This Appendix presents a summary of the submittal and funding process required to obtain funding for water conservation projects at your facility.

2. Although most water conservation measures require funding to implement, some water conservation methods can be considered "low cost/no cost" projects. This means that they cost less than \$50,000 and do not qualify as a project in terms of receiving central funding. Individual activities must fund these projects. Examples of "low cost/no cost" water conservation measures include:

- a. Repair of small leaks.
- b. Maintenance of toilets - small part purchases as required.
- c. Reducing bleed-off of cooling tower to minimum acceptable levels.
- d. Altering irrigation schedules from afternoon to morning.

3. For projects that do require significant funding amounts (i.e., greater than \$50,000), there are two major funding programs centrally managed by DoD: ECIP and FEMP.

a. ECIP, the Energy Conservation Investment Program, can be used by all Navy activities for projects that are construction in scope and are greater than \$300K in cost. ECIP projects are defined as those which require more than one year to execute and demand a significant amount of design.

APPENDIX D (Continued)

b. FEMP, the Federal Energy Management Program, covers eligible projects not funded through ECIP or claimant programs. Most water conservation projects are covered under FEMP, rather than ECIP, because they generally are not construction in scope.

4. Deciding on which funding program to use (FEMP or ECIP) is not usually done at the submittal stage. The submittal process for both programs is identical, and the decision on which funds to use is typically done by NAVFACENCOM after the project has been submitted and approved.

5. FEMP money is a type of Operations & Maintenance funding (O&M). DoD does not currently have the authority to transfer FEMP money to MILCON, Bureau of Medicine and Surgery (BUMED), or Family Housing accounts. Therefore, FEMP funding is not available for Family Housing or BUMED projects. This does not mean that projects in these areas are not valid or shouldn't be encouraged. It simply means that these projects are funded from separate funding accounts. In the case of Family Housing, water conservation retrofits are programmed into the Whole House Repair Program and accomplished at the same time as other major renovations to minimize the inconvenience to the residents of housing. You should contact your facility housing manager for more information if your housing areas have water saving opportunities.

6. Outside of the Family Housing and BUMED arenas, to be eligible for funding from either ECIP and FEMP, the project must:

a. Be greater than \$50,000 in total cost. Projects under \$50,000 are "low cost/no cost" and usually must be funded in-house, but may sometimes be grouped together and funded as one project.

b. Have an acceptable Savings to Investment Ratio (SIR). Since there is a limited amount of funding available each year, the projects submitted must compete against each other for funds. Thus, the better the SIR value, the better the chances for funding approval.

c. Have a payback of 10 years or less.

APPENDIX D (Continued)

d. Meet DoD funding obligation schedules: FEMP funds must be obligated in the same fiscal year in which approved.

e. Conserve water.

7. If you have several small projects and are considering combining them, then they should have some common thread amongst them. This could be several projects (e.g., low-flow toilets, energy efficient lighting, and variable speed motors) all within the same facility. Or a number of projects in a number of different facilities, all of which conserve water.

8. In general, related projects that conserve water and which have satisfactory economic analyses will be accepted for consideration. For example, a toilet retrofit and a landscape project might not be directly related, but if they both conserve water and have good economic analyses they will likely be considered for funding approval under FEMP.

B. KEY PLAYERS AND ROLES

1. All projects that qualify for ECIP or FEMP funding must be submitted to NAVFACENGCOCM for approval. Figure D-1 is a project programming flowchart showing the approval process. The process includes several key players or organizations, each with a specific role in funding your project. If you are unfamiliar with any of these organizations or their interest in your water project, it will be helpful to review them now. Below are the key organizations and a description of their roles in the funding process. For more information, refer to the Navy Energy Manager's Handbook.

2. The Activity:

a. Prepares and submits water projects to claimant or NFESC via the geographic Engineering Field Division (EFD). Obtains assistance from the EFD, Public Works Center (PWC), pertinent utilities, and NFESC to prepare the project submittal package.

b. Provides a maintenance program for the installed project.

APPENDIX D (Continued)

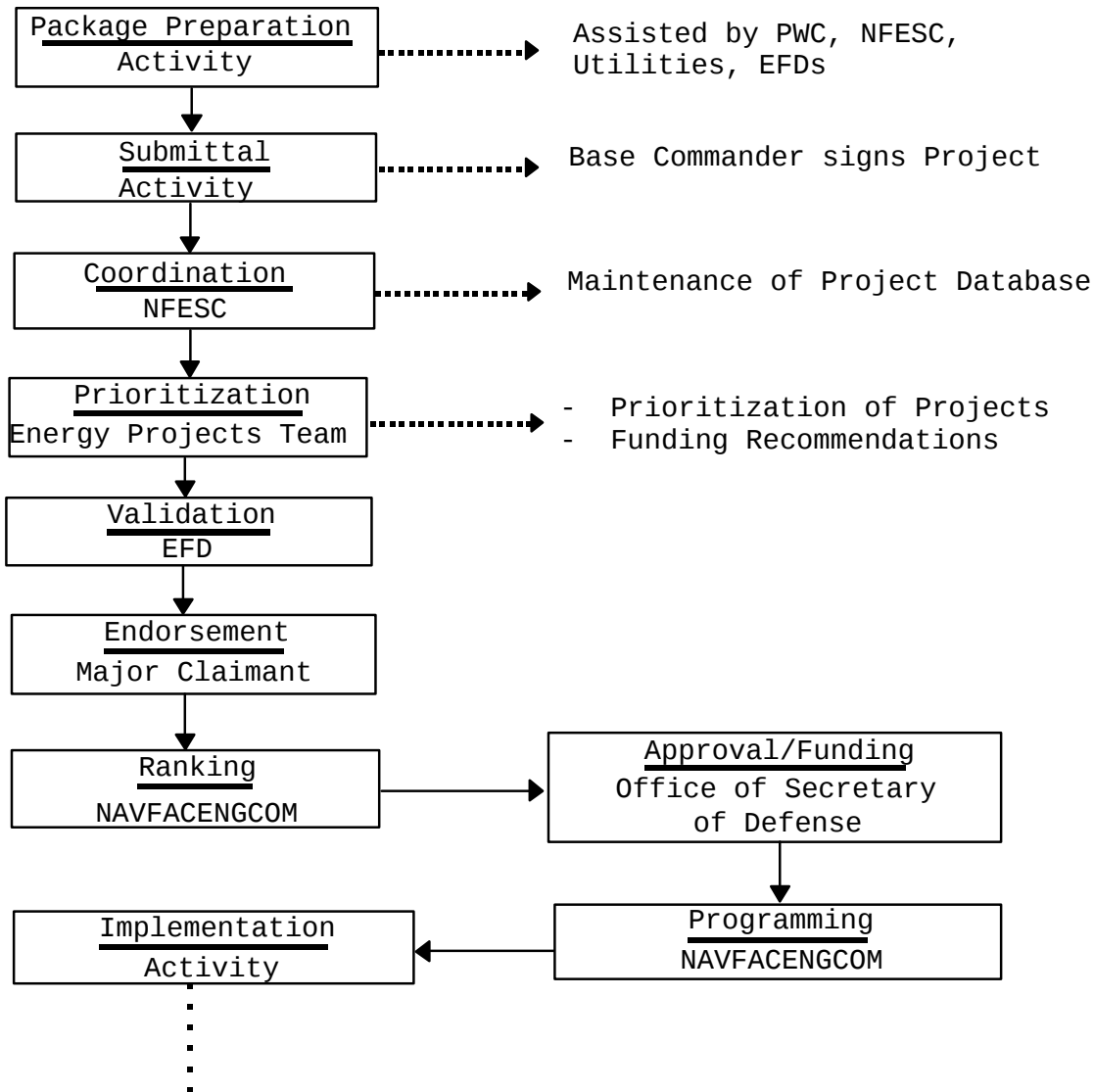

Assistance by EFD, PWC, NFESC, Contractors  
 EFD: Engineering Field Division  
 PWC: Public Works Center  
 NFESC: Naval Facilities Engineering Service Center  
 NAVFACENGCOM: Naval Facilities Engineering Command

Figure D-1  
 Navy Water Projects Programming Process

APPENDIX D (Continued)

3. EFD - Engineering Field Activity:

a. Performs technical evaluations on submitted and programmed project packages based on technical assumptions, water and cost savings, and construction cost estimates.

b. Provides assistance in identifying, developing, and auditing FEMP and ECIP projects.

c. Executes the engineering contract efforts requested by the activity.

4. Claimant:

a. Endorses EFD validated project packages depending on funding requirements, future use of the facility, and concurrence with claimant policies and directives.

b. Provides assistance to installations by using O&M standards, management guidance, and engineering expertise to identify and implement energy and water conservation efforts.

5. NFESC - Naval Facilities Engineering Service Center:

a. Reviews project submittals for consistency in technical and life cycle cost suitability and prioritizes them by SIR and payback.

b. Enters project data into a computer database and maintains the database for tracking and reporting of projects.

c. Provides technical and engineering services as well as information resource management in support of the Navy's energy and water conservation programs.

6. Energy Projects Team:

a. Made up of energy personnel from the EFD's, PWC's, NFESC and NAVFACENCOM.

APPENDIX D (Continued)

b. Prioritizes projects by SIR and payback and recommends projects to NAVFACENGCOCM for funding.

7. NAVFACENGCOCM - Naval Facilities Engineering Command:

a. Recommends projects to the Office of the Secretary of Defense (OSD) for fiscal year funding.

b. Centrally manages ECIP and FEMP funds to execute selected projects.

c. Develops and issues Navy policies and guidelines to execute water projects.

d. Develops Navy-wide execution plans for water projects.

II. THE SUBMITTAL PROCESS

A. COMPONENTS OF THE WATER PROJECT PACKAGE

1. Figure D-2 shows the components that make up a water project submittal package. There are several different parts. Assistance in completing each part can be found in NAVFACINST 11010.44, "Shore Facilities Planning Guide," and OPNAVINST 11010.20, "Facilities Projects Manual." Sample submittals can be found in the "Navy Water Conservation Guide for Shore Activities," published by the NFESC.

2. Cover Letter, Summary Sheet and List of Attachments. The cover letter should be addressed from your activity commanding officer to the NFESC (Code 20) with a copy to your EFD and major claimant. It serves as an introduction to the submittal package with a brief description of the project. Following the cover sheet is a summary sheet. The summary sheet is just that, a summary of the information in the package, with financial information from the completed Life Cycle Cost (LCC) analysis spreadsheet. After the summary sheet, a list of the submittal package contents is included. Notice that there are distinct attachment categories.

APPENDIX D (Continued)

3. DD Form 1391 through References. Details on completing these attachments and forms can be found in NAVFACINST 11010.44, and OPNAVINST 11010.20.

4. Once you have gathered all of your information and completed the submittal package, forward it to your activity's commanding officer for approval and signature on the cover letter. The deadline for submitting project packages is March 30th. It is suggested that you submit your package(s) no later than mid February to ensure that funding from the current fiscal year is received.

5. Remember that MILCON project funding can cross fiscal years, but that FEMP funding must be obligated in the same year it's approved. It may take from six to eight weeks for your project to be approved once submitted and another two to three months to receive funding. Therefore, it's always best to submit your packages as early as possible and not wait until March 30.

III. ADDITIONAL ASSISTANCE

A. REFERENCES

1. The following Navy references will assist you in developing water conservation projects for submission to NAVFACENGCOCM for approval and funding:

a. "Navy Water Conservation Guide for Shore Activities," Naval Facilities Engineering Service Center UG-2017-E&U, July 1996.

b. "Navy Energy Manager's Handbook," Dec. 1993.

c. "Shore Facilities Planning Guide," NAVFACINST 11010.44.

d. "Facilities Projects Manual," OPNAVINST 11010.20.

APPENDIX D (Continued)

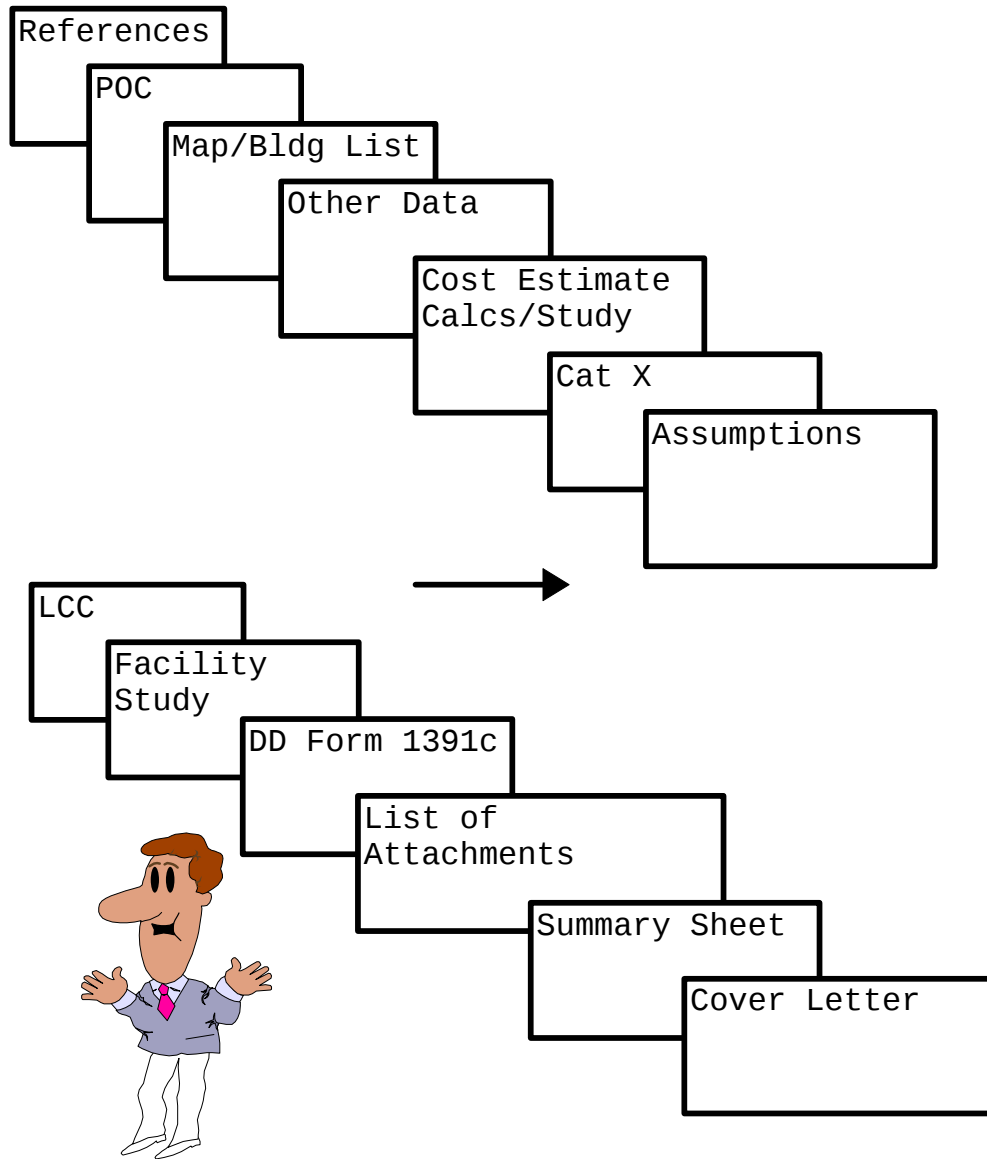

Figure D-2  
Components of the Water Project Package



APPENDIX D (Continued)

B. POINTS OF CONTACT

1. Naval Facilities Engineering Service Center (NFESC)  
1100 23rd Ave.  
Port Hueneme, CA 93043-4370
  - a. Water Program Manager  
Peter H. Hill  
(805) 982-3502 DSN 551-3502  
FAX (805) 982-5388  
e-mail: phill@nfesc.navy.mil
  - b. Water Resources/Conservation  
Daniel T. Magro  
(805) 982-3529 DSN 551-3529  
FAX (805) 982-5388  
e-mail: dmagro@nfesc.navy.mil
  - c. Leak Detection Services  
William C. Pierce  
(805) 982-3595 DSN 551-3595  
FAX (805) 982-5388  
e-mail: wpierce@nfesc.navy.mil  
  
Maria A. Zendejas  
(805) 982-6072 DSN 551-6072  
FAX (805) 982-5388  
e-mail: mzendej@nfesc.navy.mil
  - d. Submittal Package Status/EPSS  
Geoff Dann  
(805) 982-1366 DSN 551-1366  
FAX (805) 982-5388  
e-mail: gdann@nfesc.navy.mil
  - e. Life Cycle Cost (LCC)  
Gene Crank  
(805) 982-5589 DSN 551-5589  
FAX (805) 982-5388  
e-mail: gcrank@nfesc.navy.mil
2. Naval Facilities Engineering Command (NAVFACENGCOM)  
200 Stovall Street  
Alexandria, VA 22332-2300

APPENDIX D (Continued)

- a. Energy Project Management  
Joe Cloutier  
(703) 325-2480      DSN 221-2480  
FAX (703) 325-6799  
e-mail: njcloutier@hq.navfac.navy.mil
  
- b. Water Conservation Program  
Harold Usher  
(703) 325-0014      DSN 221-0014  
FAX (703) 325-6799  
e-mail: husher@hq.navfac.navy.mil
  
- 3. Civil Engineering Corps Officer School (CECOS)  
3502 Goodspeed Street (Ste 1)  
Port Hueneme, CA 93043-4336
  - a. Energy/Water Conservation Training  
Gil Siqueido  
(805) 982-4245      DSN 551-4245  
FAX (805) 982-2918  
e-mail: gsiqueido@cbcph.navy.mil

APPENDIX E  
AIR FORCE SPECIFIC PROGRAM, RESOURCES AND POC'S

I. THE AIR FORCE FUNDING PROCESS

A. TYPES OF FUNDING

1. Energy Conservation Investment Program (ECIP). ECIP is an OSD centrally managed energy program intended to help DoD meet its energy reduction goals by 2005. Projects must follow MILCON programming guidance as well as DoD program guidelines that include: a discounted payback of 10 years or less and a Savings to Investment Ratio (SIR) of at least 1.25. MAJCOMS submit candidate projects to the AFCESA every Spring for inclusion in the upcoming fiscal year's program. AFCESA prioritizes the projects, primarily based upon SIR, and a suggested priority is sent to OSD. Although not normal, it is possible to submit projects to Air Staff out of cycle. A MAJCOM can submit a project anytime to Air Staff to be added to the ECIP Program, if funds are available.

2. Facility Energy Management Program (FEMP). Any operation and maintenance funded repair project or any minor construction project less than the current minor construction limit that will reduce energy consumption, costs, provide savings in operating and maintenance costs, and help achieve the energy goals, can be considered a FEMP candidate. FEMP projects will use the same program criteria as in the ECIP program. Projects must have an estimated cost of at least \$30,000. However, the submittals for these projects will be submitted as line items and MAJCOMS and bases should follow instructions in the call letter. These line items will include a cost estimate, simple payback, estimated date of award, estimated savings, and consumption reduction.

3. Fast Payback Capital Investment Program (FASCAP). Although the DoD identifies this program as the "Productivity Enhancing Incentive Fund" (PEIF), the Air Force uses the acronym "FASCAP". This program became self-sustaining in FY92. All FASCAP projects have to cost less than \$150,000 and need to amortize within two years from the date they become operational. Projects are determined based on their Savings to Investment Ratio (SIR), and the supporting economic justifications must be validated by the base Manpower and Organization staff before proposals can be submitted to MAJCOMS.

APPENDIX E (Continued)

For additional information, consult AFI 38-301, Productivity Enhancing Capital Investment Program, 10 June 1994.

4. Productivity Investment Fund (PIF). PIF proposals have the same requirements as FASCAP, except the cost must be over \$150,000, amortized within four years from the date they become operational. MAJCOMs, FOAs, and DRUs report projected needs to HQ USAF Productivity Office every two years. Identify funds by program, appropriation, and amount. For additional information, consult AFI 38-301, Productivity Enhancing Capital Investment Program, 10 June 1994.

5. Utility Provided Programs. Energy Savings Performance Contracting (ESPC) and Demand Side Management (DSM) program assistance is available through AFCESA/CES.

B. KEY PLAYERS AND ROLES

1. At the Headquarters level of the US Air Force (HQ USAF), three primary offices are responsible for establishing Air Force energy policies for three separate functional operations. These offices include aircraft operations, vehicle operations, and installation operations. Additional information concerning personnel and points of contact can be found in Chapter 18 of the DoD Energy Managers Handbook.

2. The Technical Support Directorate, Air Force Civil Engineer Support Agency (AFCESA/CES) is responsible for providing energy program technical and implementation assistance to the AF/CEO, MAJCOMs, and bases. This assistance includes providing guidance and recommended policies for fostering energy and water efficiency in existing and general operations facilities, serving as the focal point for review and validation of the DUERS report from MAJCOMs, publishing the Energy Budget Figures in Engineering Technical Letters (ETLs), and providing technical assistance to MAJCOMs and bases on energy and water efficiency in new facilities. AFCESA/CES is the focal point for ECIP, FEMP, Private-Sector Development (PSD) financing and ESPC for energy production projects and facilities and for DSM and utility contract assistance. Table E-1 shows a detailed list of AFCESA/CES's suborganizations and the names and phone numbers of the POCs for each subject area.

APPENDIX E (Continued)

II. THE SUBMITTAL PROCESS

The submittal process and components of a water project package for FEMP and ECIP water projects are covered in detail in Air Force Energy Program Procedural Memorandum (AFEPPM) 96-4 1 June 1996, "Investment Opportunities For Energy And Water Conservation Projects." The attachments to this document contain blank submittal forms and sample cost calculations. AFEPPM 96-4 can be found and downloaded from the AFCESA web site (<http://www.afcesa.af.mil/AFCESA>).

III. ADDITIONAL ASSISTANCE

A. The following Air Force references will assist you in developing water conservation projects:

1. Air Force Energy Program Procedural Memorandum (AFEPPM) 96-1, 1 June, 1996 Air Force Energy Management Plan
2. Air Force Energy Program Procedural Memorandum (AFEPPM) 96-2, 1 June, 1996, Air Force Water Management Program
3. Air Force Energy Program Procedural Memorandum (AFEPPM) 96-4, 1 June, 1996, Investment Opportunities For Energy And Water Conservation Projects
4. A-Gram 95-42: Energy Savings Performance Contracts

## APPENDIX E (Continued)

<b>AFCESA/CES ENERGY POINTS OF CONTACT AND RESPONSIBILITIES</b>		
DSN Prefix: 523; Commercial Prefix: (904) 283; Fax Ext.: 6219		
<b>Contact name Extension</b>	<b>e-mail address (@afcesa.af.mil)</b>	<b>Responsible for:</b>
Mr. Beason 6361	HQ AFCESA/CES beasonf	Energy
Mr. Wahlgren 6338	HQ AFCESA/CES wahlgreb	Water
Mr. Day 6357	HQ AFCESA/CES daya	POL/Plumbing Natural Gas Distribution Precision Measurement Electronics Lab
Mr. Snook 6295	HQ AFCESA/CES snookj	Utility Rates
Mr. Hansen 6317	HQ AFCESA/CES hansenr	Exterior Electric Generators
Lt Col Gabriel 6348	HQ USAF/ULT gabrial	Utility Litigation Team
Mr. Anderson 6345	HQ AFCESA/CES andersom	Wastewater
Mr. Hart 6346	HQ AFCESA/CES hartq	HVAC Chlorofluorocarbons Indoor Air Quality
Mr. Doddington 6343	HQ AFCESA/CES doddingj	Heat Plants & Distribution Compressed Air
Mr. Fowler 6215	HQ AFCESA/CES fowlern	Corrosion
Mr. Fordham 6465	HQ AFCESA/CES fordhamw	Landscape/Irrigation

Figure E-1  
AFCESA/CES Energy Points Of Contact And Responsibilities

APPENDIX F  
MARINE CORPS SPECIFIC PROGRAM, RESOURCES, AND POC'S

I. THE MARINE CORPS FUNDING PROCESS

A. TYPES OF FUNDING

1. Water conservation projects may be performed as repair, retrofit, or construction (as applicable for the proposed conservation action) through any of the normal project identification, development, and execution processes. In addition, special programs are in place to specifically address water and energy conservation projects.

2. O&MMC funded repair and construction programs (M1/R1, M2/R2) can be used to repair leaks, replace defective equipment, replace fixtures and systems, etc. Water conservation projects will compete with all other projects done through these programs. Refer to MCO P11000.5, Real Property Facilities Manual Volume IV Facilities Projects Manual, for more information.

3. DoD Federal Energy Management Program (FEMP) and Energy Conservation Investment Fund (ECIP) programs are special programs that specifically address conservation projects. Contact the POC's listed at the end of this section for specific information relative to these programs. In general, FEMP is for both repair projects and construction projects that save energy and/or water, and is subject to O&M funding rules. ECIP projects must save energy (many water conservation projects also save pumping and heating costs) and are of Military Construction (MILCON) scope (construction over \$300,000).

4. Military Family Housing (MFH) water conservation projects are funded through normal MFH repair and construction programs and must compete with other projects vying for those funds. Refer to MCO P11000.22, Marine Corps Housing Management Manual, for more information on these programs.

5. Third-Party funding: Recent legislation allows installations to take advantage of utility programs to fund conservation actions through their utility contracts. This allows installation to make improvements without the need for government funding. In addition, water conservation projects that also save energy may be accomplished under Energy Savings Contracts (ESPC). ESPC is a way of paying for energy saving measures from projected savings in energy costs and related O&M

APPENDIX F (Continued)

expenses (which may include water savings). For additional information, contact the POC's listed at the end of this section.

B. KEY PLAYERS

1. Many of the key players and descriptions are the same for the Marine Corps as for the Navy (refer to APPENDIX D) with some notable exceptions. Generally, activities submit FEMP and ECIP projects to HQMC for approval and funding. In addition, activities may receive technical assistance from HQMC. Marine Corps activities are not required to submit projects to NAVFACENCOM for approval, projects are not reviewed by NFESC unless requested by the activity, and projects are not tracked by NFESC. HQMC validates FEMP, ECIP and other projects within HQMC approval levels and seeks or provides funding as necessary.

II. THE SUBMITTAL PROCESS

A. COMPONENTS OF THE WATER PROJECT PACKAGE

1. Water projects will be submitted in accordance with submittal instructions for the program funding sought. In general, ECIP and FEMP projects require a completed DD form 1391 and life cycle cost analysis performed with the latest version of the Building Life-Cycle Cost (BLCC) program developed by the National Institute of Standards and Technology (NIST). Additional requirements may vary by program from year to year so the program sponsor should be consulted. Contact the POC's listed at the end of this section for additional information on submittal requirements for FEMP and ECIP projects.

III. ADDITIONAL ASSISTANCE

A. POINTS OF CONTACT

1. Energy Programs, Technical Assistance  
Dick Walsh  
(703)696-0859      DSN 426-0859  
FAX (703)696-0849  
e-mail: walshr@mqg-smtp3.usmc.mil



MIL-HDBK-1165

APPENDIX F (Continued)

2. Utilities and Performance Contracting,  
Technical Assistance  
David Heinrichs  
(703)696-0859      DSN 426-10859  
FAX (703)696-0849  
e-mail: heinrichsd1@mqg-smtp3.usmc.mil

REFERENCES

NOTE: THE FOLLOWING REFERENCED DOCUMENTS FORM A PART OF THIS HANDBOOK TO THE EXTENT SPECIFIED HEREIN. USERS OF THIS HANDBOOK SHOULD REFER TO THE LATEST REVISIONS OF CITED DOCUMENTS UNLESS OTHERWISE DIRECTED.

FEDERAL/MILITARY SPECIFICATIONS, STANDARDS, BULLETINS, HANDBOOKS, AND NAVFAC GUIDE SPECIFICATIONS:

Unless otherwise indicated, copies are available from the Defense Printing Service Detachment Office (DPSDO), Standardization Document Order Desk, Building 4D, 700 Robbins Avenue, Philadelphia, PA 19111-5094.

	US Air Force Landscape Design Guide, Air Force Design Group at Brook Air Force Base (DSN 240-4239)
ETL 1110-3-465	U.S. Army, Design & Construction of Water Meters & Appurtenances at New Army Facilities

HANDBOOKS

MIL-HDBK-1152	Inspection and Certification of Boilers and Unfired Pressure Vessels
MIL-HDBK-1164	DoD Energy Managers Handbook Maintenance & Operation of Water Supply Systems

MARINE CORPS DOCUMENTS:

(Unless otherwise indicated, copies are available from Commanding General, Code 876, Marine Corps Logistics Base, 814 Radford Blvd., Albany, GA 31704-1128.)

MCO P11000.22	Marine Corps Housing Management Manual
MCO P11000.5	Real Property Facilities Manual, Volume IV, Facs. Projects Manual

OTHER GOVERNMENT DOCUMENTS AND PUBLICATIONS:

(Unless otherwise indicated, copies are available from the Superintendent of Documents, U.S. Government Printing Office, Washington, DC 20402.)

	Energy Policy Act of 1992 - Federal Energy Management Provisions
EPA/625/R-92/004	Guidelines for Water Reuse
Executive Order 12902	Energy Efficiency and Water Conservation at Federal Facilities

NON-GOVERNMENT PUBLICATIONS:

AMERICAN WATER WORKS ASSOCIATION (AWWA)

M6	Water Meters - Selection, Installation, Testing, and Maintenance
M36	Water Audits and Leak Detection
	Drought Management Planning
	Evaluating Urban Water Conservation Programs: A Procedures Manual
	Water Conservation (Maddaus)
	Water-Efficient Landscape Guidelines
	Xeriscape Programs for Water Utilities

(Unless otherwise indicated, copies are available from American Water Works Association (AWWA), 6666 W. Quincy Avenue, Denver, CO 80235.)

MIL-HDBK-1165

AMERICAN NATIONAL STANDARDS INSTITUTE (ANSI)

Z124.9/93

Plastic Urinal Fixtures

(Unless otherwise indicated, copies are available from American National Standards Institute (ANSI), 11 West 42nd Street, New York, NY 10036.)

GLOSSARY

A/E. Architect and Engineering.

Blackwater. Water collected from toilets, dishwashers and kitchen sinks which contains human or food wastes and requires extensive treatment before being returned for beneficial use.

Bleed-off. Water removed from air conditioning and cooling tower systems to prevent the accumulation of contaminants in the feed water.

Blowdown. Water, periodically or continuously, removed boiler systems to prevent the accumulation of contaminants in the feed water.

CTTPP. Center for Technology Transfer and Pollution Prevention.

Drought Management Plan. A comprehensive plan, developed from input from all the local water users, which outlines water practices to be observed during drought conditions.

Demand Management. Management strategies that look to reduce water use at the facility or building level by the implementation of devices and techniques which reduce water consumption by the end users.

DOE. Department of Energy.

EO. Executive Order.

EPA. Environmental Protection Agency.

FEMP. Federal Energy Management Program.

gpc. gallons per cycle.

gpd. gallons per day.

gpf. gallons per flush.

Gpm. gallons per minute.

Graywater. Water collected from showers, bathroom sinks, and laundries that can be put to some beneficial use with little or no treatment.

GSA. General Services Administration.

IWRAPS. Installation Water Resources Analysis and Planning System.

kPa. KiloPascals.

Low Cost/No Cost. Water conservation measures that can be implemented with little or no additional costs. Projects with total costs below \$50,000.

lpc. liters per cycle.

lpd. liters per day.

Lpf. liters per flush.

Lpm. liters per minute.

Make-up. Water added to an existing system, usually in a continuous stream, in order to compensate for losses in the system, such as blowdown or bleed-off.

Marginal Cost. This is the amount of money that additional water demand will add to your bill, or the amount your bill will be reduced by removing water demand.

Once Through Systems. Cooling systems which utilize water, in a single pass system, as the cooling agent.

PMB. Plastic Media Blasting.

Prioritization Survey. A survey performed at the agency level to assess the overall picture of water use and losses within DoD. It targets installations for further investigation, identifies any exempt facilities, and establishes highest priority facilities for water audits.

psi. pounds per square inch.

RO. Reverse osmoses.

Supply Management. Management strategies that are independent of the water user and which can be centrally managed by the public works office. They improve water efficiency and reduce unaccounted-for-water losses in the distribution system.

ULF. Ultra low flow.

USDA. United States Department of Agriculture.

Water Audit. The process by which all water-consuming equipment at a facility is monitored to determine water usage, water losses, and the costs associated with each.

Water Conservation. Any beneficial reduction in water use or water losses.

Water Conservation Plan. A comprehensive plan to manage your water resources and implement water conservation measures as funds become available or the measures become feasible.

Water Reclamation. Recovering water from the effluent of a waste treatment facility to use for another purpose such as golf course irrigation.

Water Recycling. Using water within the same process such as converting a once-through water cooling system to a multiple pass system.

Water Reuse. Using water from one process on another such as taking water from a cooling tower and using it to irrigate a housing area.

WAVE. Water Alliance for Voluntary Efficiency.

WELP. Water-Efficient Landscaping Planner.

Xeriscape. Water conservation through creative landscaping.

CUSTODIAN  
NAVY - YD2

PREPARING ACTIVITY  
NAVY - YD2

PROJECT NO.  
FACR-1168

